



iviceversa

Soluciones
Gráficas



X-BANNER	4
L-BANNER	6
ROLL UP BANNER	8
ROLL UP ACCESSORIES	32
MINI BANNER	36
SUCTION CUPS BANNER	38
CROSS - TRIPLE BANNER	40
BAMBOO BANNER	41
OUTDOOR BANNER	42
BEACH BANNER	53
FLYING BANNER	54
FLYING BANNER ACCESSORIES	56
BACKPACK BANNER	57
INDOOR FLYING BANNER	58
EXTERIOR SOLUTIONS	60
FASHION POP UP EXHIBITION WALL	67
BARRIER BANNER	68
FABRIC POP UP	70
POP UP	75
POP UP ACCESSORIES	84
TEXTIFX	88
TEXTIFX ACCESSORIES	110
QUICK SYSTEM	114
POSTER DISPLAY	118
PROMOTION COUNTERS	131
POSTER SYSTEM	142
DISPENSER DISPLAYS	148
TURNABLES	160



X-BANNER

- EN Interchangeable graphic system that provides a great visual impact. Portable-detachable, lightweight and easy set-up. Carry bag included.
- FR Système pour visuel interchangeable qui fournit un grand impact visuel. Portable, démontable, léger facile à démonter. Housse de transport inclus.
- PT Sistema que permite a mudança de imagem. Grande impacto visual. Transportável, móvel, leve e fácil de montar. Inclui saco de transporte.
- ES Display ligero para gráficas intercambiables. De gran impacto visual. Es portátil, desmontable y de montaje rápido. Incluye bolsa de transporte.

INFORMATION

*mm

- 3 sizes available.
- Easy to assemble.
- Carry bag is included.
- Interchangeable graphic.
- Portable and detachable.
- Fiberglass and plastic parts.

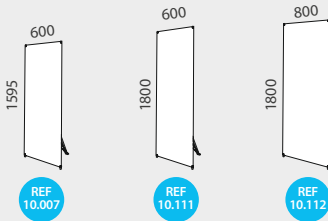

TUDELA 1595	QTY	N.W	G.W	C.B.M	SIZE
Packing	10	13.5kg	17.5kg	0.07	300x200x1080mm
Uni.	1	1.35kg	1.75kg	0.005	160x30x1080mm

10.007 Graphic Size: 600x1595mm

TUDELA 1800	QTY	N.W	G.W	C.B.M	SIZE
Packing	10	10.6kg	12.6kg	0.07	290x200x1210mm
Uni.	1	1.55kg	1.95kg	0.007	160x40x1210mm

10.111 Graphic Size: 600x1800mm

TUDELA 800x1800	QTY	N.W	G.W	C.B.M	SIZE
Packing	10	11.75kg	13.75kg	0.07	290x200x1210mm
Uni.	1	1.65kg	2.05kg	0.008	170x40x1210mm

10.112 Graphic Size: 800x1800mm

TUDELA



1.2m Width

INFORMATION

*mm

- Easy to assemble.
- Carry bag is included.
- Interchangeable graphic.
- Portable and detachable.
- Aluminium, fiberglass and plastic.

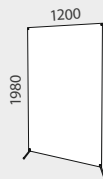

VALORIA	QTY	N.W	G.W	C.B.M	SIZE
Packing	10	17kg	19kg	0.08	300x200x1410mm
Uni.	1	1.70kg	1.90kg	0.008	200x30x1360mm

10.006 Graphic Size: 1200x1980mm

VALORIA

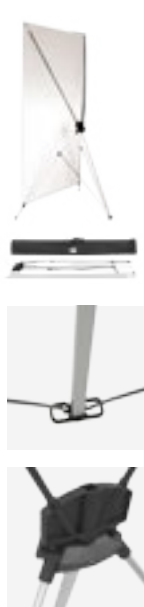

X-BANNER | Economic X-Banner



INFORMATION

*mm

- 5 sizes available.
- Fast to assemble.
- Carry bag is included.
- Fiberglass and plastic.
- Interchangeable graphic.
- Portable and detachable.

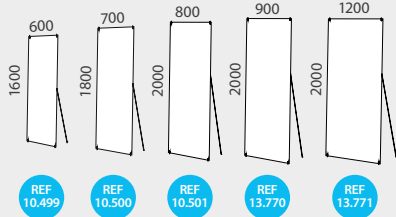

LILLE	QTY	N.W	G.W	C.B.M	SIZE
Packing	50	16.5kg	17.5kg	0.1298	350x350x1060mm
Uni.	1	0.30kg	0.35kg	0.009	140x60x1060mm

*** 10.499** Graphic Size: 600x1600mm

LYON	QTY	N.W	G.W	C.B.M	SIZE
Packing	50	20kg	22kg	0.1484	400x350x1060mm
Uni.	1	0.35kg	0.40kg	0.009	140x60x1060mm

*** 10.500** Graphic Size: 700x1800mm

MARSEILLE	QTY	N.W	G.W	C.B.M	SIZE
Packing	50	22.5kg	23.5kg	0.192	400x400x1200mm
Uni.	1	0.40kg	0.45kg	0.01	140x60x1200mm

*** 10.501** Graphic Size: 800x2000mm

CANNES	QTY	N.W	G.W	C.B.M	SIZE
Packing	20	14.6kg	15.7kg	0.178	1210x410x360mm
Uni.	1	0.73kg	1kg	0.01	140x60x1200mm

*** 13.770** Graphic Size: 900x2000mm

CHARTRES	QTY	N.W	G.W	C.B.M	SIZE
Packing	20	22kg	23.2kg	0.193	1260x510x300mm
Uni.	1	1.1kg	1.3kg	0.01	140x60x1200mm

*** 13.771** Graphic Size: 1200x2000mm



ECONOMIC

MARKET LEADER
BEST SELLER
HIGH QUALITY



L-BANNER

- EN Interchangeable graphic system that can provide a great visual impact. Portable-Detachable and lightweight. Easy set-up. Carry bag included.
- FR Système pour visuel interchangeable qui fournit un grand impact visuel. Portable, démontable, léger facile à démonter. Housse de transport inclus.
- PT Sistema que permite a mudança de imagem, grande impacto visual. Transportável, móvel, leve e fácil de montar. Inclui saco de transporte.
- ES Display ligero para gráficas intercambiables. De gran impacto visual. Es portátil, desmontable y de montaje rápido. Incluye bolsa de transporte.

lightweight and fast to assemble



INFORMATION

*mm

- Easy to assemble.
- Carry bag is included.
- Interchangeable graphic.
- Portable and detachable.
- Fiberglass and plastic parts.

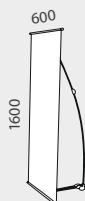

MESTANZA	QTY	N.W	G.W	C.B.M	SIZE
Packing	25	10kg	11.25kg	0.073	300x230x1060mm
Uni.	1	0.40kg	0.45kg	0.004	140x30x1060mm

10.774 Graphic Size: 600x1600mm

MESTANZA

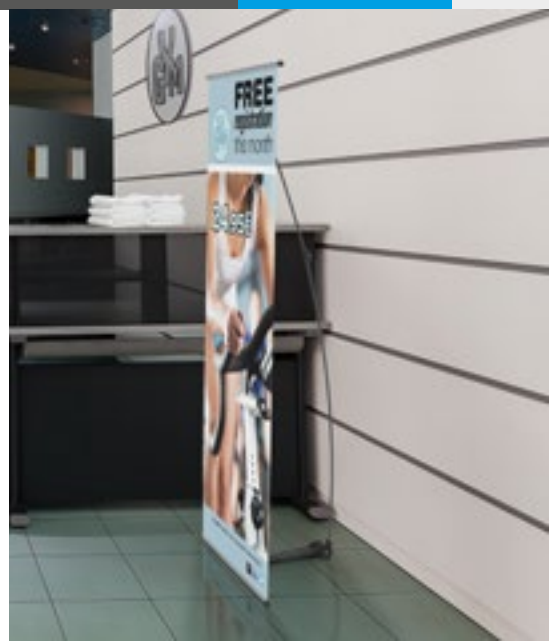
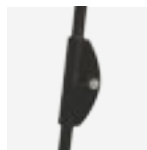
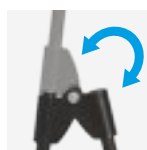
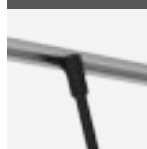

NAVAS

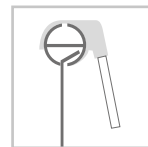

graphic with adhesive strip

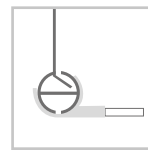

INFORMATION

*mm

- Easy to assemble.
- Carry bag is included.
- Interchangeable graphic.
- Portable and detachable.
- Fiberglass and plastic parts.
- Graphic with adhesive strip.

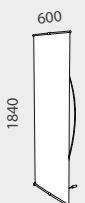

NAVAS	QTY	N.W	G.W	C.B.M	SIZE
Packing	20	14kg	20kg	0.081	340x240x1000mm
Uni.	1	0.70kg	1kg	0.012	110x110x930mm

10.001 Graphic Size: 600x1840mm



INFORMATION

*mm

- Easy to assemble.
- 490mm "L" depth.
- Carry bag is included.
- Interchangeable graphic.
- Portable and detachable.
- Aluminium and plastic parts.

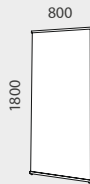

BONN	QTY	N.W	G.W	C.B.M	SIZE
Packing	10	12kg	14kg	0.048	230x200x1050mm
Uni.	1	1.2kg	1.35kg	0.023	200x125x950mm

10.575 Graphic Size: 800x1800mm

BONN



double sided

adjustable height

Telescopic

INFORMATION

*mm

- Telescopic.
- Double sided.
- Easy to assemble.
- Carry bag is included.
- Interchangeable graphic.
- Portable and detachable.
- Aluminium and plastic parts.

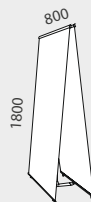

SELLA	QTY	N.W	G.W	C.B.M	SIZE
Packing	10	16.5kg	18kg	0.048	230x200x1050mm
Uni.	1	1.65kg	1.80kg	0.009	100x100x920mm

10.437 Graphic Size: 800x1800mm

SELLA





ROLL UP	
EN	Retractable banner stand. Installed within seconds. It's portable and detachable. Produced in anodized aluminium, plastic parts and other materials (depending on model). Carry bag is included.
FR	Enrouleur. L'assemblage peut être réalisé en quelques secondes. Fabriqué en différents matériaux (aluminium, plastique, acier, etc...). Léger et facile à monter. Sac de transport inclus.
PT	Expositor retráctil. Monta-se em segundos. Permite a mudança de imagem facilmente. Fabricado em diferentes materiais (alumínio, plástico, aço, etc...). Saco de transporte incluído.
ES	Expositor enrollable de gráfica intercambiable. Portátil, ligero y desmontable. Fabricados en aluminio, plástico y otros materiales según modelo. Montaje rápido y sencillo. Incluye bolsa de transporte.



ABADIA



INFORMATION *mm

- Easy to assemble.
- Carry bag is included.
- Interchangeable graphic.
- Portable and detachable.
- Aluminium and plastic parts.
- Ideal to display in front of columns.



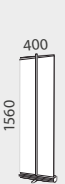

REF 10.568

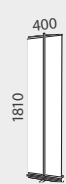

REF 10.569



REF 10.570

ABADIA 1560	QTY	N.W	G.W	C.B.M	SIZE
Packing	10	13.5kg	13.8kg	0.03	400x210x460mm
Uni.	1	1.35kg	1.38kg	0.003	95x95x430mm

10.568 Graphic Size: 400x1560mm

ABADIA 1810	QTY	N.W	G.W	C.B.M	SIZE
Packing	10	13.9kg	14.2kg	0.04	450x210x460mm
Uni.	1	1.39kg	1.42kg	0.004	95x95x430mm

10.569 Graphic Size: 400x1810mm

ABADIA 2060	QTY	N.W	G.W	C.B.M	SIZE
Packing	10	14.2kg	14.5kg	0.04	450x210x460mm
Uni.	1	1.42kg	1.45kg	0.004	95x95x430mm

10.570 Graphic Size: 400x2060mm

ideal to display
in front of
columns



ALZIRA

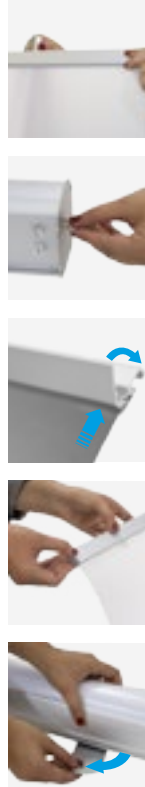

INFORMATION

*mm

- Easy to assemble.
- Carry bag is included.
- Interchangeable graphic.
- Portable and retractable.
- Aluminium and plastic parts.
- Ideal to display in front of columns.

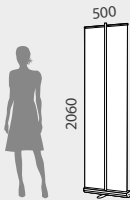

ALZIRA	QTY	N.W	G.W	C.B.M	SIZE
Packing	6	9kg	10.20kg	0.05	340x240x580mm
Uni.	1	1.50kg	1.70kg	0.007	110x110x580mm

 10.093 Graphic Size: 500x2060mm

portable
and detachable



ALBARES

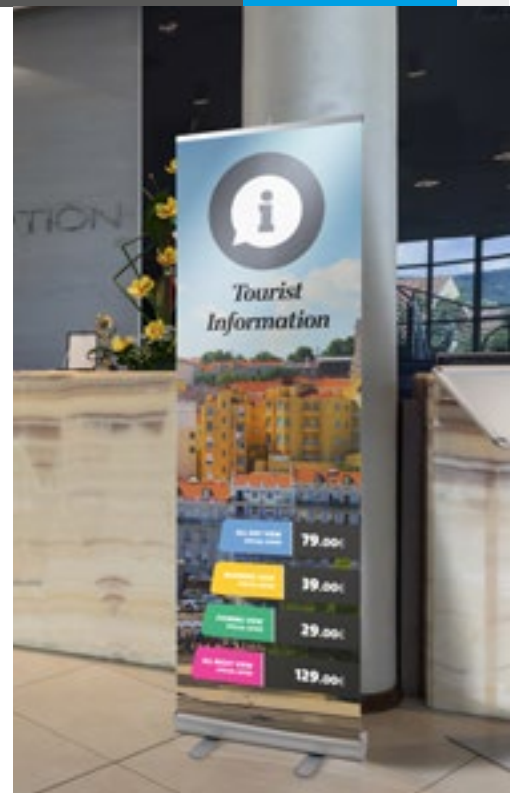

INFORMATION

*mm

- Easy to assemble.
- Carry bag is included.
- Interchangeable graphic.
- Portable and retractable.
- Aluminium and plastic parts.

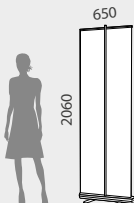

ALBARES	QTY	N.W	G.W	C.B.M	SIZE
Packing	6	9.60kg	10.60kg	0.06	340x240x730mm
Uni.	1	1.60kg	1.80kg	0.008	110x110x700mm

 10.094 Graphic Size: 650x2060mm

ECONOMIC



metal connector

improved stability

hand strap



SIDNEY

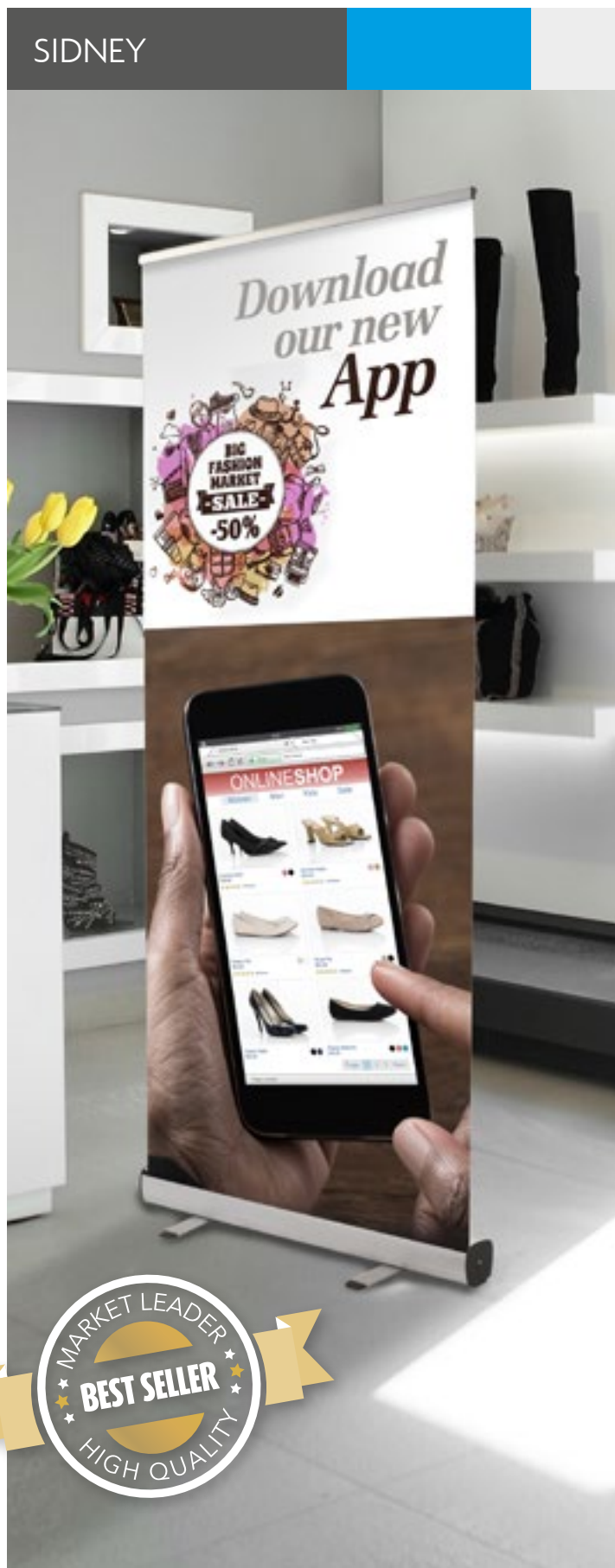

INFORMATION

*mm

- Fast to assemble.
- With metal connector.
- Interchangeable graphic.
- Portable and retractable.
- Hand strap carry bag included.
- With a special piece for stability.
- Aluminium, metal and plastic parts.

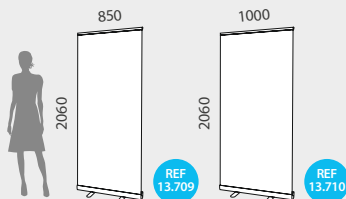

SIDNEY 850	QTY	N.W	G.W	C.B.M	SIZE
Packing	6	10.5kg	11.40kg	0.054	300x200x900mm
Uni.	1	1.75kg	1.90kg	0.007	90x90x875mm
13.709	Graphic Size: 850x2060mm				
SIDNEY 1000	QTY	N.W	G.W	C.B.M	SIZE
Packing	6	12.3kg	13.08kg	0.063	300x200x1050mm
Uni.	1	2.05kg	2.18kg	0.008	90x90x1040mm
13.710	Graphic Size: 1000x2060mm				





metal connector



improved stability



shoulder and hand strap

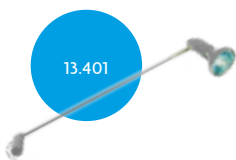

13.401

optional spotlight
- sold apart *

INFORMATION

*mm

- Metal connector.
- Easy to assemble.
- Interchangeable graphic.
- Portable and retractable.
- Aluminium and plastic parts.
- With a special piece for stability.
- Shoulder and hand strap carry bag included.

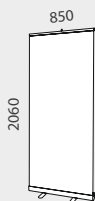

ALCALA



ALCALA	QTY	N.W	G.W	C.B.M	SIZE
Packing	10	20.93kg	21.4kg	0.08	475x200x900mm
Uni.	1	1.85kg	2.09kg	0.007	90x90x875mm

✳ 10.801

Graphic Size: 850x2060mm

* optional spotlight (sold apart, see later Roll Up accessories at this chapter)



ECONOMIC

plastic connector

improved stability

hand strap

ALBANY



INFORMATION *mm

- Fast to assemble.
- With plastic connector.
- Interchangeable graphic.
- Portable and retractable.
- Aluminium and plastic parts.
- Hand strap carry bag included.
- With a special piece for stability.

850

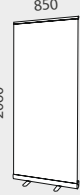

2060

REF 10.061

1000



2060

REF 10.380

ALBANY 850	QTY	N.W	G.W	C.B.M	SIZE
Packing	6	10kg	14kg	0.06	310x210x860mm
Uni.	1	1.50kg	2.3kg	0.01	90x90x1040mm
* 10.061	Graphic Size: 850x2060mm				
ALBANY 1000	QTY	N.W	G.W	C.B.M	SIZE
Packing	10	20.8kg	22.1kg	0.063	480x200x1050mm
Uni.	1	2.08kg	2.21kg	0.01	90x90x1040mm
* 10.380	Graphic Size: 1000x2060mm				

ALGAR

NEW



INFORMATION

*mm

- Metal connector.
- Easy to assemble.
- Interchangeable graphic.
- Portable and retractable.
- Aluminium and plastic parts.
- With a special piece for stability.
- With hand strap carry bag included.

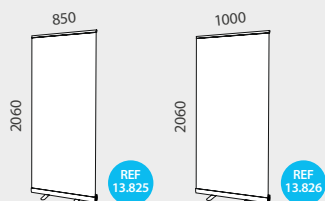

ALGAR 850	QTY	N.W	G.W	C.B.M	SIZE
Packing	6	15kg	16kg	0.0776	330x250x940mm
Uni.	1	2.5kg	3kg	0.021	180x130x900mm
13.825	Graphic Size: 850x2060mm				

ALGAR 1000	QTY	N.W	G.W	C.B.M	SIZE
Packing	6	18kg	19kg	0.0899	330x250x1090mm
Uni.	1	3kg	3.5kg	0.024	180x130x1040mm
13.826	Graphic Size: 1000x2060mm				





ECONOMIC

single oxford bag

INFORMATION

- 4 sizes available.
- Easy to assemble.
- Carry bag is included.
- Interchangeable graphic.
- Portable and retractable.
- Aluminium and plastic parts.

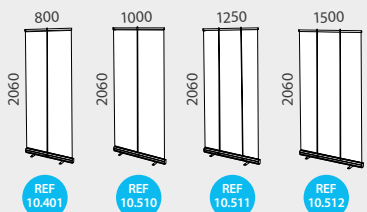

ALAMEDA	QTY	N.W	G.W	C.B.M	SIZE
Packing	6	10kg	14kg	0.06	310x210x860mm
Uni.	1	1.5kg	2.30kg	0.006	90x90x840mm
*10.401	Graphic Size: 800x2060mm				

AVILES	QTY	N.W	G.W	C.B.M	SIZE
Packing	10	20.8kg	22.1kg	0.10	480x200x1060mm
Uni.	1	2.08kg	2.21kg	0.008	90x90x1040mm
*10.510	Graphic Size: 1000x2060mm				

RIBADEO	QTY	N.W	G.W	C.B.M	SIZE
Packing	6	15.30kg	16.5kg	0.078	300x200x1300mm
Uni.	1	2.55kg	2.75kg	0.012	95x95x1270mm
*10.511	Graphic Size: 1250x2060mm				

NAVIA	QTY	N.W	G.W	C.B.M	SIZE
Packing	6	17.70kg	18.60kg	0.093	300x200x1550mm
Uni.	1	2.95kg	3.10kg	0.013	100x95x1520mm
*10.512	Graphic Size: 1500x2060mm				



ALAMEDA
AVILES
RIBADEO
NAVIA

ROLL UP BANNER | Standard Roll Up



double padded bag

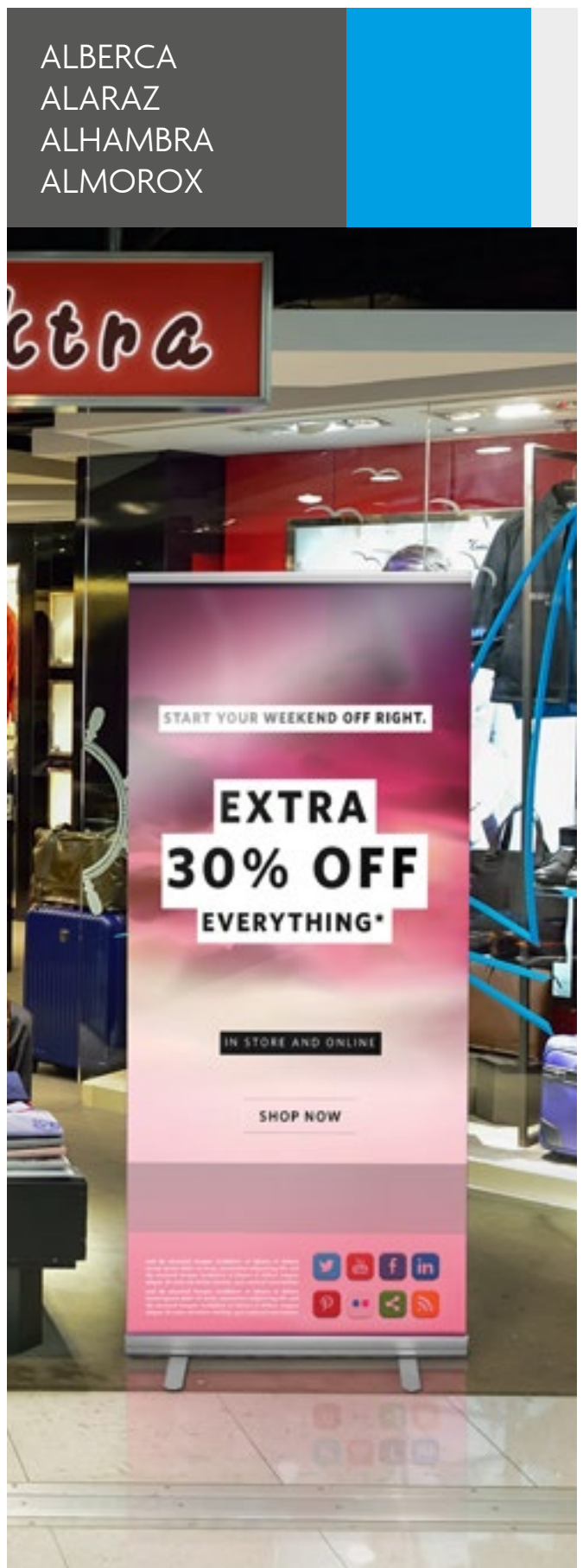

INFORMATION *mm

- 4 sizes available.
- Easy to assemble.
- Interchangeable graphic.
- Portable and retractable.
- Aluminium and plastic parts.
- Double padded bag included.

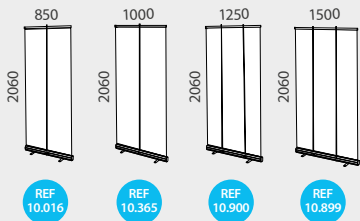

ALBERCA	QTY	N.W	G.W	C.B.M	SIZE
Packing	6	12.60kg	14.40kg	0.07	320x230x910mm
Uni.	1	2.10kg	2.40kg	0.009	100x100x890mm

10.016 Graphic Size: 850x2060mm

ALARAZ	QTY	N.W	G.W	C.B.M	SIZE
Packing	6	13.80kg	16.20kg	0.08	320x220x1060mm
Uni.	1	2.30kg	2.70kg	0.011	100x100x1040mm

10.365 Graphic Size: 1000x2060mm

ALHAMBRA	QTY	N.W	G.W	C.B.M	SIZE
Packing	6	18kg	21kg	0.12	320x220x1310mm
Uni.	1	3kg	3.50kg	0.012	100x100x1300mm

10.900 Graphic Size: 1250x2060mm

ALMOROX	QTY	N.W	G.W	C.B.M	SIZE
Packing	6	19.8kg	22.8kg	0.109	320x220x1560mm
Uni.	1	3.30kg	3.80kg	0.015	100x100x1540mm

10.899 Graphic Size: 1500x2060mm

ROLL UP BANNER | Highly Resistant Roll Up



10.056

optional spotlight
- sold apart *

9 sizes
available

reinforced
with steel



quick and
simple set-up

EN Reinforced Steel Base.
FR En acier renforcé.

PT Com reforço em aço.
ES Base reforzada en acero.

ALGECIRAS



* optional spotlight (sold apart; see later Roll Up accessories)

INFORMATION

*mm

- Portable.
- Retractable.
- Easy set-up.
- With Carry bag.
- Highly resistant.
- Aluminium and plastic.
- Interchangeable graphic.

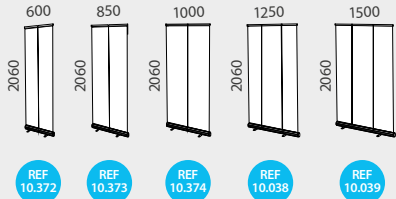

ALGECIRAS 600	QTY	N.W	G.W	C.B.M	SIZE
Packing	6	12.9kg	15kg	0.0464	320x220x910mm
Uni.	1	2.15kg	2.5kg	0.0109	125x130x660mm

10.372 Graphic Size: 600x2060mm

ALGECIRAS 850	QTY	N.W	G.W	C.B.M	SIZE
Packing	6	17.1kg	19.20kg	0.0640	310x220x910mm
Uni.	1	2.85kg	3.20kg	0.0145	125x130x895mm

10.373 Graphic Size: 850x2060mm

ALGECIRAS 1000	QTY	N.W	G.W	C.B.M	SIZE
Packing	6	18kg	21kg	0.0746	320x220x1065mm
Uni.	1	3kg	3.5kg	0.0173	125x130x1050mm

10.374 Graphic Size: 1000x2060mm

ALGECIRAS 1250	QTY	N.W	G.W	C.B.M	SIZE
Packing	4	15kg	17kg	0.1265	370x260x1315mm
Uni.	1	3.75kg	4.25kg	0.0213	125x130x1300mm

10.038 Graphic Size: 1250x2060mm

ALGECIRAS 1500	QTY	N.W	G.W	C.B.M	SIZE
Packing	4	18kg	20kg	0.1519	370x260x1580mm
Uni.	1	4.5kg	5kg	0.0256	125x130x1565mm

10.039 Graphic Size: 1500x2060mm

ALGECIRAS



INFORMATION *mm

REF 10.375 REF 10.376 REF 10.377 REF 10.378

EN	Reinforced Steel Base.	PT	Com reforço em aço.
FR	En acier renforcé.	ES	Base reforzada en acero.



ALGECIRAS 1750	QTY	N.W	G.W	C.B.M	SIZE
Packing	4	22kg	24kg	0.133	260x280x1830mm
Uni.	1	5.5kg	6kg	0.0333	130x140x1830mm

10.375 **Graphic Size: 1750x2060mm**

ALGECIRAS 2200	QTY	N.W	G.W	C.B.M	SIZE
Uni.	1	7kg	7.4kg	0.0353	125x125x2260mm

10.377 **Graphic Size: 2200x2060mm**

ALGECIRAS 2000	QTY	N.W	G.W	C.B.M	SIZE
Packing	2	14kg	15kg	0.0569	230x120x2060mm
Uni.	1	7kg	7.5kg	0.0343	130x130x2045mm

10.376 **Graphic Size: 2000x2060mm**

ALGECIRAS 2400	QTY	N.W	G.W	C.B.M	SIZE
Uni.	1	7.6kg	8kg	0.0384	125x125x2460mm

10.378 **Graphic Size: 2400x2060mm**

ROLL UP BANNER | Black Roll Up | Tablet Holder Roll Up



INFORMATION

*mm

This Roll Up features a full black finish and it is made of durably aluminum so it is incredibly lightweight and saves floor space. With an easy change of graphic, set up is quick and easy, just connect the pole to the base, roll-up the graphic and hook it at the top of the pole. With canvas carry bag included. Ideal for trade shows, expositions, retail stores or any media event.

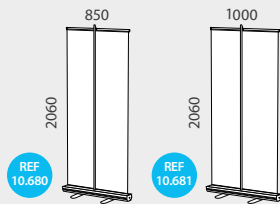

ALTEA 850	QTY	N.W	G.W	C.B.M	SIZE
Packing	10	22kg	24kg	0.093	490x210x910mm
Uni.	1	2.20kg	2.40kg	0.007	90x90x875mm
*10.680	Graphic Size: 850x2060mm				
ALTEA 1000	QTY	N.W	G.W	C.B.M	SIZE
Packing	10	25kg	26kg	0.109	490x210x1060mm
Uni.	1	2.50kg	2.60kg	0.011	105x105x1040mm
*10.681	Graphic Size: 1000x2060mm				

ALTEA



* optional spotlight (sold apart, see later Roll Up accessories at Cap. 1)

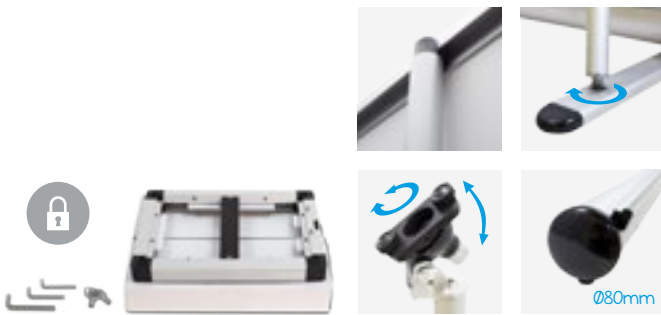

INFORMATION

*mm

- Easy to assemble.
- Safety (with lock).
- 360° rotating frame.
- 2 tablet holder sizes.
- Carry bag is included.
- Portable and retractable.
- Interchangeable graphic.
- Aluminium and plastic parts.



TABLET HOLDER 1	QTY	N.W	G.W	C.B.M	SIZE
Packing	1	0.75kg	0.90kg	0.003	260x47x310mm
		3.60kg	4.10kg	0.013	130x110x930mm
10.035	Roll Up Graphic Size: 850x2060mm Size for Tablets: ±185.8x241.3mm				
TABLET HOLDER 2	QTY	N.W	G.W	C.B.M	SIZE
Packing	1	0.75kg	0.90kg	0.003	260x47x310mm
		3.60kg	4.10kg	0.013	130x110x930mm
10.053	Roll Up Graphic Size: 850x2060mm Size for Tablets: ±195.5x240mm				

TABLET HOLDER ROLL UP



(tablet is not included)

quick and simple set-up

canvas carry bag is included



INFORMATION

*mm

This Roll Up banner is made of durably aluminum with plastic parts so it is incredibly lightweight and have a slim-line design that makes the unit visually appealing and saves floor space. With an easy change of graphic, set up is quick and easy, users can simply connect the pole to the base, roll-up the graphic and hook the banner at the top of the pole. Additionally, a canvas carry bag is included. Ideal for trade shows, expositions, retail stores or any media event.

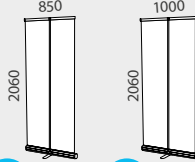

REF 13.578

REF 13.579

DUERO 850	QTY	N.W	G.W	C.B.M	SIZE
Packing	6	14.4kg	14.8kg	0.0786	320x270x910mm
Uni.	1	2.4kg	2.8kg	0.01	110x105x890mm
* 13.578	Graphic Size: 850x2060mm				
DUERO 1000	QTY	N.W	G.W	C.B.M	SIZE
Packing	6	16.8kg	17.4kg	0.0926	320x270x1060mm
Uni.	1	2.8kg	3.3kg	0.011	105x105x1040mm
* 13.579	Graphic Size: 1000x2060mm				

DUERO TRIANGLE ROLL UP



silver finished side caps with triangular shape

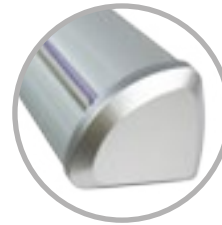

DEHESA



telescopic



INFORMATION

*mm

This Roll Up banner is made of durably aluminum with plastic parts so it is incredibly lightweight and saves floor space. Featuring stylish open bases and adjustable height thanks to its telescopic pole. With an easy change of graphic, set up is quick and easy. Additionally, a canvas carry bag is included. Ideal for trade shows, expositions, retail stores or any media event.



DEHESA	QTY	N.W	G.W	C.B.M	SIZE
Packing	6	19.20kg	23kg	0.09	360x260x910mm
Uni.	1	3.15kg	3.50kg	0.01	110x110x900mm
10.020	Graphic Size: 850x828-2260mm				

VALDAVIA



INFORMATION

*mm

This Roll Up banner is made of durably aluminum with plastic parts so it is incredibly lightweight and saves floor space. Featuring single but sturdy base for a stylish displaying. With an easy change of graphic, set up is quick and easy. Additionally, a canvas carry bag is included. Ideal for trade shows, expositions, retail stores or any media event.

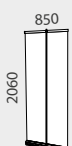

VALDAVIA	QTY	N.W	G.W	C.B.M	SIZE
Packing	6	22.80kg	25.20kg	0.07	320x230x910mm
Uni.	1	3.80kg	4.20kg	0.01	110x105x890mm
10.017	Graphic Size: 850x2060mm				

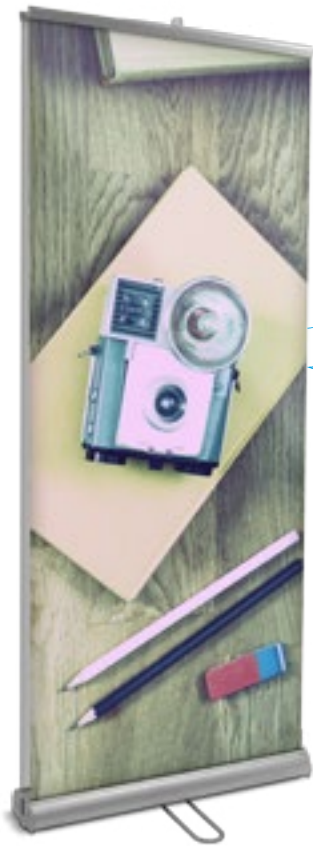

INFORMATION

*mm

- Double sided.
- 4 sizes available.
- Easy to assemble.
- Carry bag included.
- Interchangeable graphic.
- Portable and retractable.

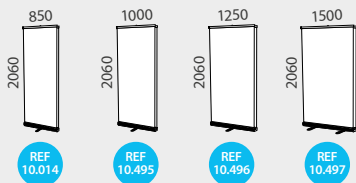

FONTIVEROS 850	QTY	N.W	G.W	C.B.M	SIZE
Packing	3	13kg	15kg	0.06	350x190x930mm
Uni.	1	4.40kg	4.70kg	0.021	180x130x900mm
* 10.014	Graphic Size:850x2060mm				

FONTIVEROS 1000	QTY	N.W	G.W	C.B.M	SIZE
Packing	3	15.60kg	16.80kg	0.07	350x190x1280mm
Uni.	1	5.20kg	5.60kg	0.024	180x130x1040mm
* 10.495	Graphic Size:1000x2060mm				

FONTIVEROS 1250	QTY	N.W	G.W	C.B.M	SIZE
Packing	3	20.40kg	21.60kg	0.09	350x190x1280mm
Uni.	1	6.80kg	7.20kg	0.025	115x175x1280mm
* 10.496	Graphic Size:1250x2060mm				

FONTIVEROS 1500	QTY	N.W	G.W	C.B.M	SIZE
Packing	3	24kg	25.20kg	0.11	350x190x1580mm
Uni.	1	8kg	8.40kg	0.033	180x120x1550mm
* 10.497	Graphic Size:1500x2060mm				







INFORMATION

*mm

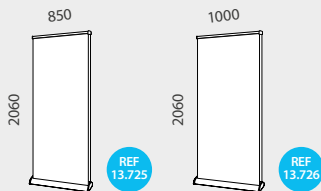
- Leveling feet.
- Double sided.
- 2 sizes available.
- Carry bag included.
- Interchangeable graphic.
- Portable and retractable.
- Stable base with no-feet design.



MORA 850	QTY	N.W	G.W	C.B.M	SIZE
Packing	4	16kg	17kg	0.072	890x190x430mm
Uni.	1	4.20kg	5.20kg	0.021	900x130x180mm
	13.725	Graphic Size: 850x2060mm			

MORA 1000	QTY	N.W	G.W	C.B.M	SIZE
Packing	4	19kg	20kg	0.084	1040x190x430mm
Uni.	1	4.90kg	5.90kg	0.024	1040x130x180mm
	13.726	Graphic Size: 1000x2060mm			





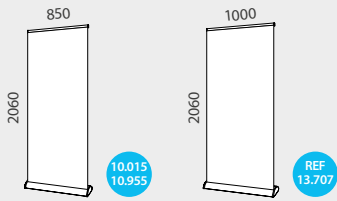

INFORMATION

*mm

- Leveling feet.
- Easy to assemble.
- Silver or black color.
- Carry bag included.
- Interchangeable graphic.
- Portable and retractable.
- Luxury Banner Stand finished.



CERVERA 850	QTY	N.W	G.W	C.B.M	SIZE	
Packing	4	18.2kg	23kg	0.16	530x300x980mm	
Uni.	1	4.55kg	5.75kg	0.018	150x135x920mm	
 10.015	Graphic Size: 850x2060mm					

CERVERA 1000	QTY	N.W	G.W	C.B.M	SIZE	
Packing	4	19kg	23.8kg	0.17	530x300x980mm	
Uni.	1	4.75kg	5.95kg	0.0216	150x135x1070mm	
 13.707	Graphic Size: 1000x2060mm					

CERVERA 850	QTY	N.W	G.W	C.B.M	SIZE	
Packing	4	18.2kg	23kg	0.16	530x300x980mm	
Uni.	1	4.55kg	5.75kg	0.018	150x135x920mm	
 10.955	Graphic Size: 850x2060mm					

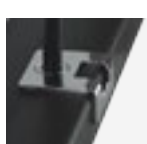
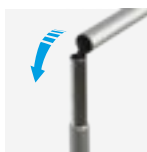

luxury
finish

ASTI

LUXURY





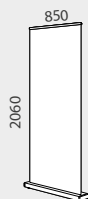

INFORMATION

*mm

- Leveling feet.
- Easy to assemble.
- Silver or black color.
- Carry bag included.
- Interchangeable graphic.
- Portable and retractable.
- Luxury Banner Stand finished.



ASTI 850	QTY	N.W	G.W	C.B.M	SIZE	
Packing	4	19.6kg	21kg	0.126	500x260x970mm	
Uni.	1	4.90kg	5.20kg	0.018	150x135x920mm	
 10.657	Graphic Size: 850x2060mm					
ASTI 850	QTY	N.W	G.W	C.B.M	SIZE	
Packing	4	19.6kg	21kg	0.126	500x260x970mm	
Uni.	1	4.90kg	5.20kg	0.018	150x135x920mm	
 10.656	Graphic Size: 850x2060mm					

EN With wooden table and brochureholders included.
FR Avec tablette et porte documents inclus.

PT Expositor retráctil com porta-folhetos e prateleira.
ES Con estante de madera y portafolletos incluidos.



with brochure holders



Features wooden table



INFORMATION

*mm

- Easy to assemble.
- Carry bag included.
- Interchangeable graphic.
- Portable and retractable.
- Luxury Banner Stand finished.
- With table and A4 brochure holders.

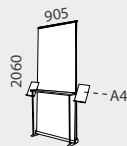

BREMEN



BREMEN	QTY	N.W	G.W	C.B.M	SIZE
Packing	1	6.30kg	6.95kg	0.037	250x150x990mm
10.826	Graphic Size:905x2060mm				

IBIZA

outdoor
or indoor

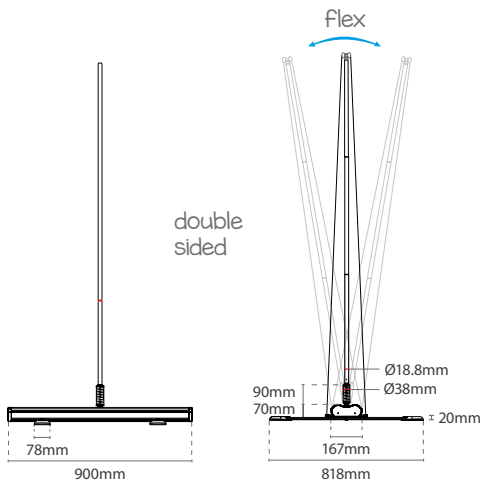

double
sided

flex

INFORMATION

*mm

- Easy to assemble.
- Carry bag is included.
- Flex and double sided.
- Indoor or outdoor use.
- Interchangeable graphic.
- Portable and retractable.
- Aluminium and plastic parts.



IBIZA	QTY	N.W	G.W	C.B.M	SIZE
Packing	1	7.6kg	8.8kg	0.03	300x110x930mm
 10.447	Graphic Size: 850x2060mm				

ASCOLI

outdoor
or indoor

double
sided

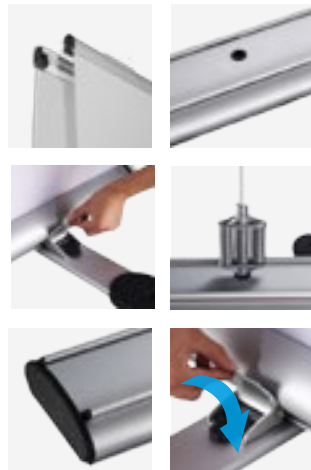
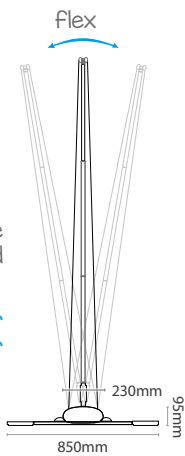

INFORMATION

*mm

- Easy to assemble.
- Carry bag is included.
- Flex and double sided.
- Indoor or outdoor use.
- Interchangeable graphic.
- Portable and retractable.
- Aluminium and plastic parts.



ASCOLI	QTY	N.W	G.W	C.B.M	SIZE
Packing	2	7.6kg	8.28kg	0.026	255x115x920mm
 10.655	Graphic Size: 850x2060mm				



RIBAS

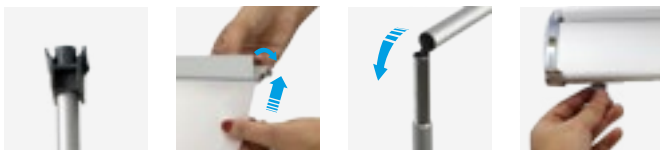

RIBAS	QTY	N.W	G.W	C.B.M	SIZE
Packing	4	22kg	26.6kg	0.16	530x300x980mm
Uni.	1	5.5kg	6.65kg	0.03	250x135x920mm



10.013 Graphic Size: 850x2060mm

INFORMATION

*mm

- Leveling feet.
- Double sided.
- Easy to assemble.
- Carry bag included.
- Interchangeable graphic.
- Portable and retractable.
- Luxury Banner Stand finished.

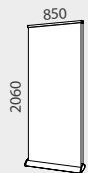

PINEDA SCROLL
ROLL UP BANNER

EN	Electrically powered. It allows rotation of the graphic.
FR	Scrolling Roll Up permettant la rotation "scroll" du visuel.
PT	Permite a colocação de uma imagem com efeito rotativo.
ES	Roll Up eléctrico que permite la rotación de la gráfica.



luxury
finished

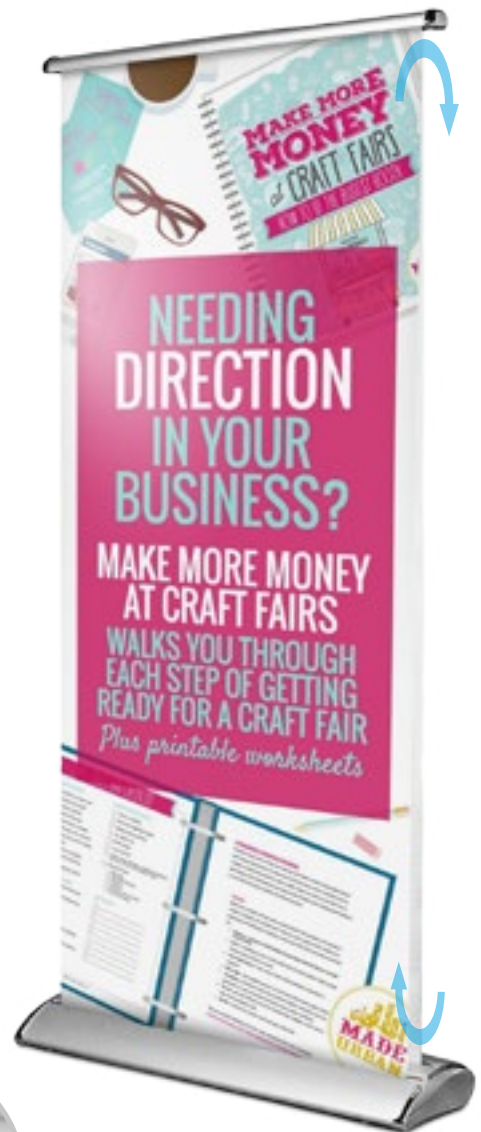

with
leveling feet



PINEDA	QTY	N.W	G.W	C.B.M	SIZE
Packing	4	19.80kg	24.60kg	0.16	530x300x980mm
Uni.	1	4.95kg	6.15kg	0.034	280x130x925mm

* 10.022 Graphic Size: 780x4105mm

INFORMATION

*mm

- Leveling feet.
- Electrical scrolling.
- Carry bag included.
- Interchangeable graphic.
- Portable and retractable.
- Luxury Banner Stand finished.

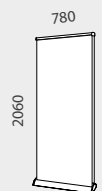

NEPAL

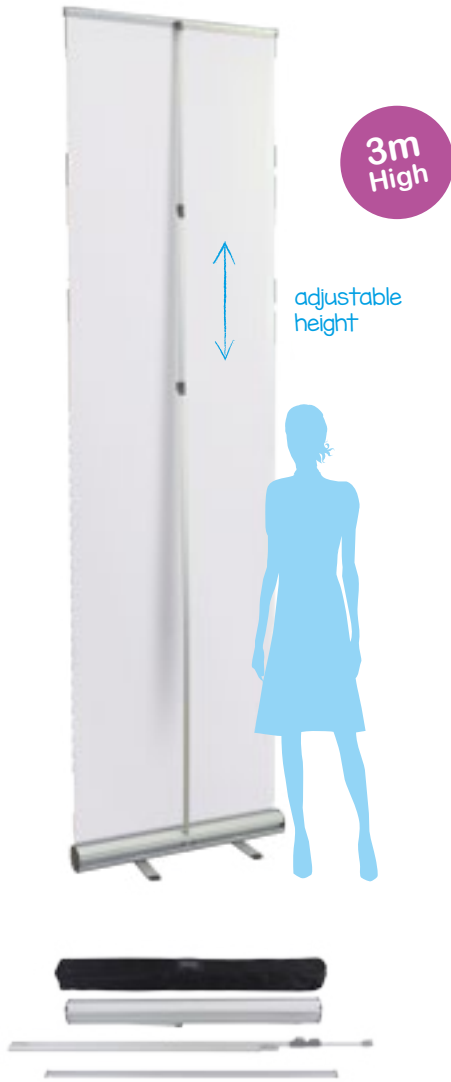

INFORMATION

*mm

The Nepal Roll Up banner is made of durably aluminum with plastic parts and features an adjustable height up to 3m to grab the attention of anyone in the room. Set up is quick and easy, and users can adjust the height tilting lowering the Roll Up Banner. Additionally, a canvas carry bag is included. The Nepal Roll Up is perfect for trade shows, convention centers, malls, expositions, retail stores or any media event where their large graphics can be seen from at the distance.

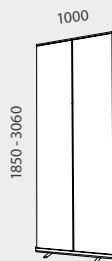
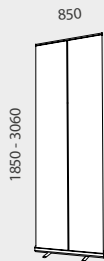

NEPAL 850	QTY	N.W	G.W	C.B.M	SIZE
Packing	6	24kg	25kg	0.098	380x280x920mm
Uni.	1	4kg	4.2kg	0.0145	125x130x895mm

13.583

Graphic Size: 850x1850-3060mm

NEPAL 1000	QTY	N.W	G.W	C.B.M	SIZE
Packing	6	28.2kg	29kg	0.1138	380x280x1070mm
Uni.	1	4.7kg	4.83kg	0.017	125x130x1050mm

13.584

Graphic Size: 1000x1850-3060mm

NEPAL



quick and simple set-up

4 widths available



INFORMATION

*mm

The Nepal Roll Up banner has 4 widths available. The width of 1500mm and 2000mm has 2 pertigas in its structures for a better firmness. Also, the 2000mm wide model has 3 bases to improve its stability. This Roll Up banner stand is an extra wide, extra tall marketing display that is perfect as a backdrop in trade show booths, press conferences, and other promotional events. Because it is so large, the Nepal 1500mm and 2000mm wide are especially suitable when your message needs to be seen from a distance.

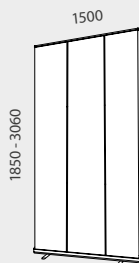

If you are looking for something bigger, the 2000mm wide, being the widest roll up of the series Nepal is the perfect alternate to a trade show booth or pop up display. Create a unique backwall design that is equally as impressive as the standard Pop Up exhibits. Nepal Roll Up 2000mm wide is perfect for trade shows, convention centers, press conferences, expositions or media events to create a lasting impression with event attendees at every exhibit.

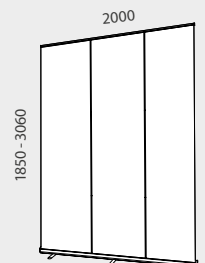

NEPAL 1500	QTY	N.W	G.W	C.B.M	SIZE
Packing	2	13.8kg	15kg	0.064	270x150x1580mm
Uni.	1	6.9kg	7.5kg	0.025	125x130x1565mm

✿ 13.585

Graphic Size: 1500x1850-3060mm

NEPAL 2000	QTY	N.W	G.W	C.B.M	SIZE
Packing	1	9.5kg	11kg	0.0468	150x150x2080mm
Uni.	1	9.5kg	11kg	0.0468	150x150x2080mm

✿ 13.586

Graphic Size: 2000x1850-3060mm

EVEREST



INFORMATION

*mm

The Everest Roll Up banner is made of durably aluminum with magnetic side connection parts. Featuring 3m height, Everest is designed to grab the attention of anyone in the room. At the top of each banner stand, there are patented magnetic connectors that allow you to join together the multiple units with a simple "click". The magnets are located on the sides of the banner rails at the top of each display. Because of its size, the Everest Roll Up graphic mural is a great alternative to pop up displays and trade show booths. Set up is quick and easy, and users can adjust the height tilting lowering the Roll Up Banner. Additionally, a canvas carry bag is included. This Roll Up makes a great graphic mural in trade show booths, press conferences, convention centers, malls, expositions, retail stores or any media event where their large graphics can be seen from at the distance.

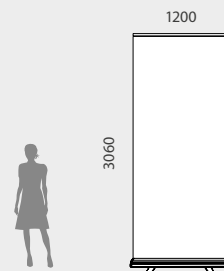

EVEREST	QTY	N.W	G.W	C.B.M	SIZE
Packing	6	40.20kg	45kg	0.15	420x290x1260mm
Uni.	1	6.50kg	7.30kg	0.018	120x120x1260mm

✿ 10.861

Graphic Size: 1200x3060mm



MONT BLANC

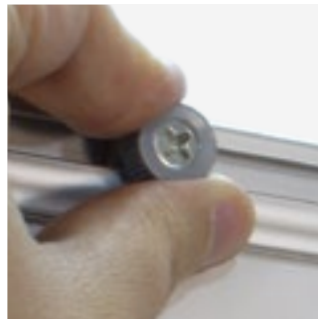

INFORMATION

*mm

If you are looking for something bigger, the Mont Blanc Roll Up Banner is 2000mm wide and features an adjustable height up to 3060mm to grab the attention of anyone in the event. Mont Blanc is the perfect alternate to a trade show booth or pop up display. Due to the large height of this banner stand, assembly is easiest when you set up along the floor and then stand the display up. Also thanks to its telescopic capacity, it is not necessary to find locations with high ceilings to be able to expose it, with a minimum height of 1700mm, the roll up Mont Blanc can be used in any other smaller places. The banner stand comes with a carrying bag to make transport of your display simple. This bag protects the unit when not in use, and a shoulder strap makes moving the bag easy. Create a unique backwall design that is equally as impressive as the standard Pop Up exhibits. Mont blanc Roll Up is perfect for trade shows, convention centers, press conferences, expositions or media events to create a lasting impression with event attendees at every exhibit.

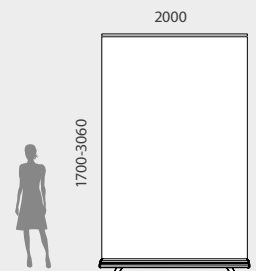

MONT BLANC	QTY	N.W	G.W	C.B.M	SIZE
Packing	1	13kg	14.80kg	0.061	180x160x2120mm

✿ 10.441

Graphic Size: 2000x1700-3060mm

ROLL UP ACCESSORIES | Bags

SINGLE OXFORD BAG



EN Single bag for Roll Up.

FR Housse pour Roll Up.

PT Saco simples para Roll Up.

ES Bolsa simple para Roll Up.

INFORMATION

*mm

- With Zipper on one side.
- Shoulder and hand strap.
- With transparent pocket for Id Tag.



850-1250

OXFORD 850	QTY	N.W	G.W	C.B.M	SIZE
Packing	1	0.12kg	0.22kg	0.0035	120x30x980mm
 13.461	For Roll Up 850mm				

OXFORD 1000	QTY	N.W	G.W	C.B.M	SIZE
Packing	1	0.15kg	0.25kg	0.0037	120x30x1030mm
 13.462	For Roll Up 1000mm				

OXFORD 1250	QTY	N.W	G.W	C.B.M	SIZE
Packing	1	0.17kg	0.30kg	0.0046	120x30x1300mm
 13.433	For Roll Up 1250mm				

* Roll Up not included / Roll Up non inclus / Roll Up não incluídos / Roll Up no incluidos.

DOUBLE PADDED BAG



double padded

EN Double padded reinforced.

FR Housse matelassée.

PT Almofoadado com fecho.

ES Con interior acolchado.

INFORMATION

*mm

- Double padded.
- With Zipper on one side.
- Shoulder and hand strap.
- With transparent pocket for Id Tag.



500-1000

D.PADDED 500	QTY	N.W	G.W	C.B.M	SIZE
Packing	1	0.20kg	0.40kg	0.004	120x40x600mm
 13.494	For Roll Up 500mm				

D.PADDED 650	QTY	N.W	G.W	C.B.M	SIZE
Packing	1	0.28kg	0.50kg	0.004	120x40x750mm
 13.495	For Roll Up 650mm				

D.PADDED 850	QTY	N.W	G.W	C.B.M	SIZE
Packing	1	0.40kg	0.60kg	0.004	120x40x980mm
 13.463	For Roll Up 850mm				

D.PADDED 1000	QTY	N.W	G.W	C.B.M	SIZE
Packing	1	0.50kg	0.70kg	0.004	120x40x1030mm
 13.464	For Roll Up 1000mm				

* Roll Up not included / Roll Up non inclus / Roll Up não incluídos / Roll Up no incluidos.



DOUBLE PADDED ZIPPED BAG

EN Double Padded and all crossed zipped.

FR Housse matelassée avec fermeture latérale.

PT Saco de Roll Up almofoadado com fecho lateral.

ES Acolchada y con cremallera cruzada alrededor.

double padded

INFORMATION

*mm

- All crossed zipped.
- Shoulder and hand strap.
- With transparent pocket for Id Tag.

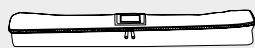

850



1000

D.P.ZIPPED 850	QTY	N.W	G.W	C.B.M	SIZE
Packing	1	0.40kg	0.60kg	0.004	120x40x980mm
 13.459	For Roll Up 850mm				

D.P.ZIPPED 1000	QTY	N.W	G.W	C.B.M	SIZE
Packing	1	0.50kg	0.70kg	0.004	120x40x1030mm
 13.460	For Roll Up 1000mm				

* Roll Up not included / Roll Up non inclus / Roll Up não incluídos / Roll Up no incluidos.

* Roll Up not included / Roll Up non inclus / Roll Up não incluídos / Roll Up no incluidos.

- EN "Deluxe" finished carry black padded bag with sided zip for Roll Up.
- FR Housse "Deluxe" pour Roll Up avec fermeture à glissière latérale.
- PT Saco de transporte de alta qualidade com fecho lateral para Roll Up.
- ES Bolsa de transporte "Deluxe" para Roll Up con cremallera lateral.



EVA BAG DELUXE



double padded

INFORMATION

- Deluxe hard case.
- All crossed zipped.
- Double padded reinforcement.
- Adjustable shoulder and hand strap.
- Eva Bag case is ideal for preserving and prolonging the life of your Roll Ups. This case prevents your Roll Up from being damaged while transporting due to its internal padded reinforcement. Also, it is very comfortable to carry thanks to its hand and shoulder straps. It has a compartment for personal ID identification.



EVA	QTY	N.W	G.W	C.B.M	SIZE
Packing	1	1.05kg	1.45kg	0.016	130x130x950mm
 13.472	For Roll Up 850mm				

EN PVC Graphic case, adjustable length. 2 colors and 3 sizes.

FR Porte-visuel, télescopique en PVC. 2 couleurs et 3 dimensions.

PT Tubo extensível em PVC. Disponível em 2 cores e 3 tamanhos.

ES Porta-Gráficas extensible en PVC. Disponibles 2 colores y 3 tamaños.

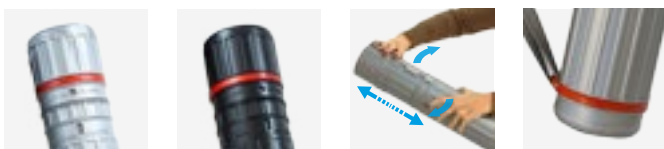

GRAPHIC CASE



adjustable length

GRAPHIC CASE 1	QTY	N.W	G.W	C.B.M	SIZE
Uni.	1	0.4kg	0.42kg	0.006	100x100x640mm
 10.074	Ø107mm 640-1070mm				
 10.075					
GRAPHIC CASE 2	QTY	N.W	G.W	C.B.M	SIZE
Uni.	1	0.5kg	0.52kg	0.008	100x100x780mm
 10.076	Ø107mm 779-1280mm				
 10.077					
GRAPHIC CASE 3	QTY	N.W	G.W	C.B.M	SIZE
Uni.	1	0.3kg	0.32kg	0.004	80x60x630mm
 10.078	Ø85mm 630-1070mm				
 10.079					



ROLL UP ACCESSORIES | Spotlights

EN Spotlights for Roll Up. Bulb type Halogen (included) and directional head, large luminous capacity. Spotlight works directly plugged in.

FR Foyer d'éclairage pour Roll Up. Halogène (incluse avec tête orientable, grande capacité d'éclairage. Se branche directement sur le secteur.

PT Focos de iluminação ideal para Roll Up. Cabeça direcional. Inclui cabo com ficha para ligação à tomada e lâmpada.

ES Focos de iluminación para Roll Up. Bombilla halógena (incluida) y cabeza direccional. Funciona a corriente. Gran capacidad luminosa.

PLUG-IN SPOTLIGHT FOR ROLL UP







plug-in base

INFORMATION

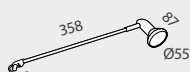
*mm

- Finished in black or matt aluminium.
- Suitable for Roll Ups with Plug-in base at top the pole.



PLUG-IN	QTY	N.W	G.W	C.B.M	SIZE
Uni.	1	0.30kg	0.40kg	0.002	80x70x460mm
 10.055		50 w			
 10.056					

CAP SPOTLIGHT FOR ROLL UP







fitted cap base

INFORMATION

*mm

- Finished in black or silver.
- Suitable for Roll Ups with Fitted cap base at top the pole.



CAP	QTY	N.W	G.W	C.B.M	SIZE
Uni.	1	0.30kg	0.35kg	0.002	100x70x400mm
 10.057		50 w			
 13.401					

EN LED light spotlight with clamp adjustment for Roll Up. Works directly plugged in.

FR Foyer d'éclairage à LED pour Roll Up. Se branche directement sur le secteur.

PT Foco de iluminação para Roll Up. LED. Com ficha para ligação à tomada e lâmpada.

ES Foco de luz LED para Roll Up. Fijación mediante pinza. Funciona directamente a corriente.





INFORMATION

*mm

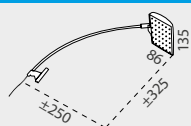
- 12w LED light.
- Chromed finished.
- With clamp for quick and easy use.



LED CLAMP	QTY	N.W	G.W	C.B.M	SIZE
Packing	1	0.4kg	0.8kg	0.0038	150x50x510mm
 10.687	12 w				

LED CLAMP SPOTLIGHT FOR ROLL UP



12w LED light

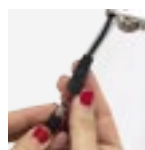

works directly plugged in



- EN Telescopic spotlight for Roll Up.
- FR Foyer d'éclairage pour Roll Up.
- PT Foco de Iluminação para Roll Up.
- ES Foco telescópico para Roll Up.



INFORMATION

*mm

- 60w halogen bulb included. Telescopic (adjustable length).
- With 2 adapters for tops of the pole (plug-in and cap bases).
- Ideal to fit most Roll Ups on market. Large luminous capacity.



TELESCOPIC	QTY	N.W	G.W	C.B.M	SIZE		
Packing	1	0.30kg	0.35kg	0.0016	125x65x200mm		
	10.525			60 w			

TELESCOPIC SPOTLIGHT FOR ROLL UP

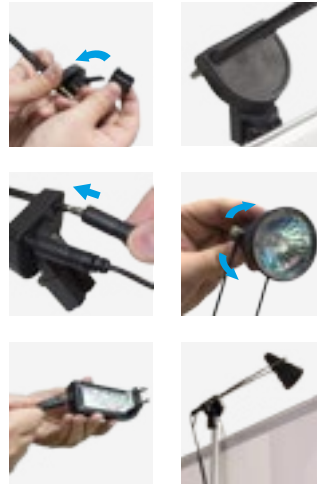

2 top of pole adapters



OXFORD BAG FOR ROLL UP SPOTLIGHTS

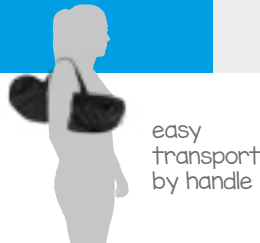

- EN Oxford nylon bag for Roll Up Spotlights.
- FR Housse en nylon pour spotlights de Roll Up.
- PT Mala Oxford em nylon para focos de Roll Up.
- ES Bolsa Oxford de nylon para focos de Roll Up.



INFORMATION

*mm

- Made of black nylon and all crossed zipped.
- The Oxford Bag protects and extends the life of your Roll Up Spotlights. Easy transport by handle.



OXFORD BAG	QTY	N.W	G.W	C.B.M	SIZE		
Packing	1	0.10kg	0.20kg	0.002	190x30x370mm		
	13.454						

MAGNET DISPENSER FOR ROLL UP



magnetic attachment

- EN Leaflet dispenser, in A6 size with double magnet.
- FR Support porte-brochures A6 avec double aimant.
- PT Porta-folhetos acrílico A6 com iman duplo.
- ES Soporte portacatálogos A6 con doble imán.



INFORMATION

*mm

- A6 leaflet size.
- Double magnetic.
- No tools required.
- Ideal for any Roll Up.



MAGNET DISPENSER	QTY	N.W	G.W	C.B.M	SIZE		
Packing	5	0.85kg	0.95kg	0.004	165x130x215mm		
	10.860	Graphic Size: A6		x5			

* Spotlights not included / Spotlights non inclus / Focos não incluídos / Focos no incluídos.

MINI BANNER | Desk Displays

EN Displays for desks and counters. PT Displays de mesa e contadores.
FR Displays à présenter sur table. ES Displays de mostrador o sobremesa.

DAGANZO LED WRITING BOARD



write and erase
your draws !

12 neon effects

rechargeable
battery

* marker
not included



INFORMATION

- Battery Rechargeable.
- 12 Modes of Neon Effects.
- Re-Writable and erasable.
- Screen eraser included.
- A4 and A5 sizes available.
- Really bright LED Effect.

- Ideal for promoting upcoming shows, special offers, dinners, special drinks at your bar or restaurant. Also useful at party drawing as notice board and more.







REF 10.308



REF 10.307

DAGANZO A4	QTY	N.W	G.W	C.B.M	SIZE	
Packing	20	13.0kg	26.0kg	0.09	480x360x540mm	  
Uni.	1	0.65kg	1.30kg	0.05	260x100x340mm	
 10.307	Graphic Size: A4					

DAGANZO A5	QTY	N.W	G.W	C.B.M	SIZE	
Packing	40	7.6kg	15.6kg	0.1	440x420x530mm	  
Uni.	1	0.19kg	0.39kg	0.003	170x100x220mm	
 10.308	Graphic Size: A5					



* pencil not included

TORRICO MINI ROLL UP



INFORMATION





- 2 sizes available A3/A4.
- Interchangeable graphic.
- Portable and retractable.
- Aluminium and plastic.
- Ideal for promoting special offers or for promoting business.



REF 10.787



REF 10.786

TORRICO A3	QTY	N.W	G.W	C.B.M	SIZE	
Packing	50	17.5kg	19kg	0.0881	705x250x500mm	
Uni.	1	0.35kg	0.6kg	0.0014	90x45x345mm	
 10.786	Graphic Size: A3					
TORRICO A4	QTY	N.W	G.W	C.B.M	SIZE	
Packing	50	15kg	17kg	0.0656	525x250x500mm	
Uni.	1	0.3kg	0.4kg	0.001	90x45x260mm	
 10.787	Graphic Size: A4					

KRAKOW MINI FLYING

printed on textil

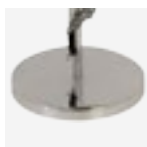

* pencil not included

INFORMATION

*mm

- Steel base, fiberglass and printed on textil.
- Ideal for promotional use on counters or desks.



KRAKOW	QTY	N.W	G.W	C.B.M	SIZE
Packing	1	0.30kg	0.35kg	0.0003	30x12x850mm
 10.596	Graphic Size: 550mm (Height)				



TORDESILLAS MINI X-BANNER

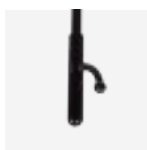
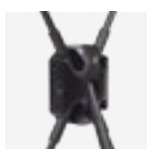



* pencil not included

INFORMATION

*mm

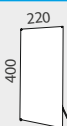
- Fiberglass structure. Interchangeable graphic.
- Ideal for promotional use on counters or desks.



TORDESILLAS	QTY	N.W	G.W	C.B.M	SIZE
Packing	200	10kg	14kg	0.07	380x140x500mm
Uni.	1	0.05kg	0.05kg	0.00045	45x35x285mm
 10.009	Graphic Size: 220x400mm				

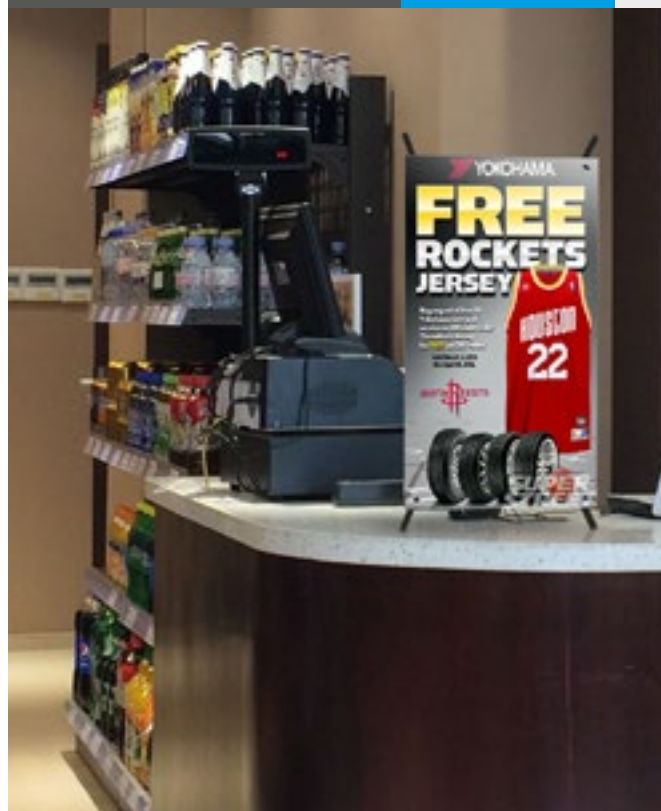

SUCTION CUPS BANNER | Windows / Glass Banners



EN Fixing system for graphics using suction cups.

PT Sistema de colocação de imagens através de ventosas.

FR Système de fixation de visuel avec ventouse.

ES Sistema de fijación de gráficas mediante ventosas.

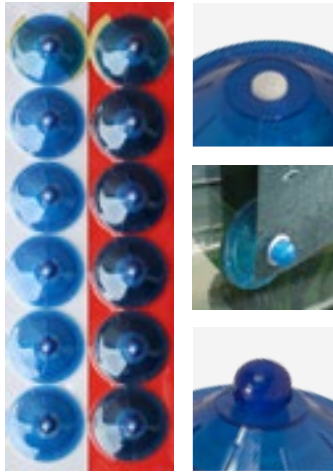



INFORMATION

*mm

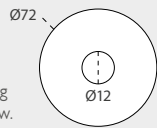
- Great fixation. 12 units pack.
- The Vargas system allows attach a banner instantly to any window or glass surface.
- Ideal for boutiques, retail stores or bakeries, for displaying your promos, sales or services right to your storefront window.



VARGAS	QTY	N.W	G.W	C.B.M	SIZE
Packing	12	0.4kg	0.45kg	0.04	580x170x40mm
 10.798				x12 	

VARGAS

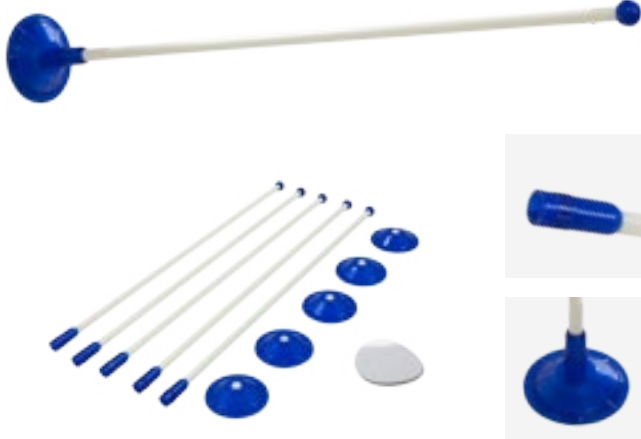

INFORMATION

*mm

- 5 units pack.
- Great fixation.
- Ideal for displaying your business at your window shop.



CANO	QTY	N.W	G.W	C.B.M	SIZE
Packing	5	0.5kg	0.55kg	0.002	170x20x640mm
 10.797		Graphic Width: 500mm		x5 	

CANO



VISO



adhesive +
magic tape

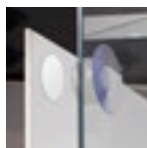

INFORMATION

*mm

- 4 units pack.
- Great fixation thanks its Ø65mm suction cup.
- Peel off the adhesive with one of the "magic tapes" and fix it to the graphic. Adjust it with "magic tape" of the suction cups.
- Ideal for changing and graphic adjustment thanks its "magic tape".

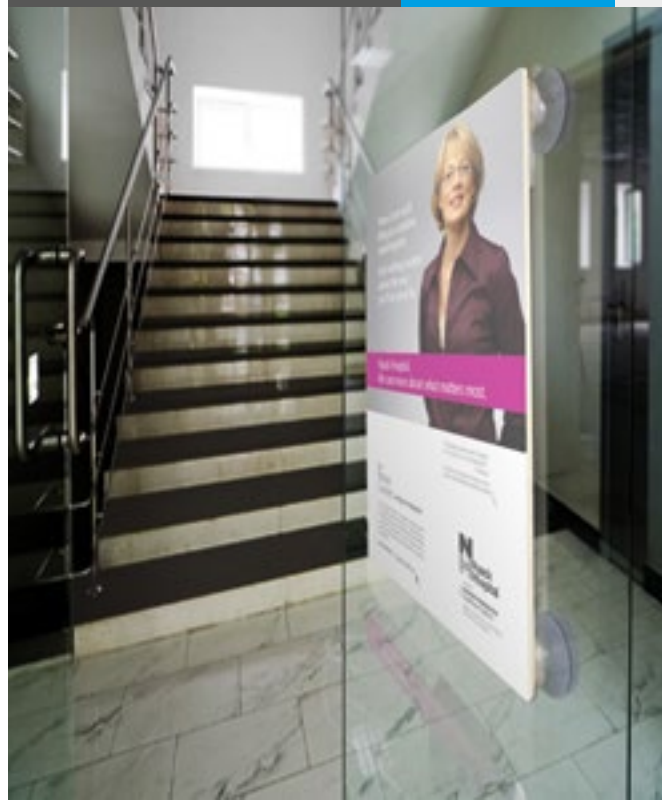
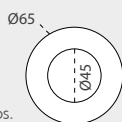

VISO	QTY	N.W	G.W	C.B.M	SIZE
Packing	4	0.09kg	0.15kg	0.0008	120x80x80mm
10.779	x4				

GABIN

clear
holder

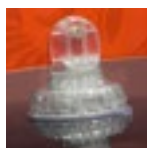

3-10mm
adjustable
thickness



maximum
fixation



INFORMATION

*mm

- Great fixation.
- Ideal for holding graphs between 3/10mm thickness thanks to its reinforced fixing suction cup.

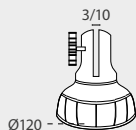

GABIN	QTY	N.W	G.W	C.B.M	SIZE
Packing	1	0.25kg	0.3kg	0.001	125x125x125mm
10.595					Suction Cup Size: Ø120mm

CROSS - TRIPLE BANNER | Tormes | Almeida | Galende



EN Double sided or triple banner display. Made of aluminium and plastic parts.

FR Support visuel double/triple face. Présentoir fabriqué en aluminium et plastique.

PT Expositor de alumínio e plástico que permite a colocação de duas ou três impressões.

ES Expositores para el empleo de dos o tres gráficas promocionales. Aluminio y partes de plástico.

TORMES CROSS BANNER

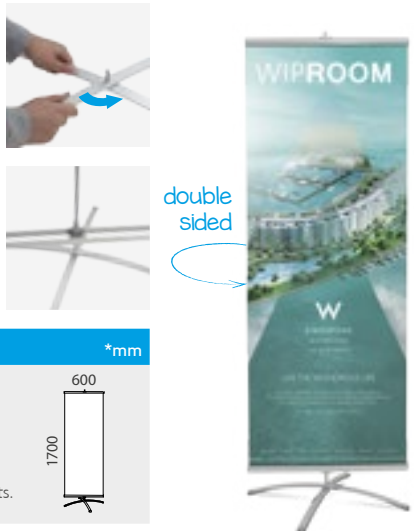

INFORMATION *mm

- Double sided.
- Easy to assemble.
- Carry bag is included.
- Interchangeable graphic.
- Aluminium and plastic parts.

TORMES	QTY	N.W	G.W	C.B.M	SIZE
Packing	10	14.50kg	18kg	0.08	340x240x980mm
Uni.	1	1.45kg	1.80kg	0.007	85x85x930mm
10.010	Graphic Size: 600x1700mm				

ALMEIDA CROSS BANNER



INFORMATION *mm

- Double sided.
- Easy to assemble.
- Carry bag is included.
- Interchangeable graphic.
- Aluminium and plastic parts.

ALMEIDA	QTY	N.W	G.W	C.B.M	SIZE
Packing	10	26kg	29kg	0.11	340x240x1280mm
Uni.	1	2.60kg	2.90kg	0.014	120x100x1170mm
10.708	Graphic Size: 1000x2000mm				



INFORMATION *mm

- Triple sided.
- Easy to assemble.
- Carry bag is included.
- Interchangeable graphic.
- Aluminium and plastic parts.

top view

GALENDE	QTY	N.W	G.W	C.B.M	SIZE
Packing	5	14kg	16kg	0.064	400x150x1080mm
Uni.	1	2.65kg	3.05kg	0.016	160x160x650mm
10.012	Graphic Size: 915x2150mm (x3)				

GALENDE TRIPLE BANNER



BAMBOO BANNER | X-Banner | Easel | Roll Up



EN Bamboo banner stand, allows an easy change of graphics. Stylish and functional design.

FR Support visuel X-Banner, élégant et fonctionnel fabriqué en bambou. Léger et démontable.

PT Expositor em bambu que permite uma mudança rápida de imagem. Desenho elegante e funcional.



ES Expositores ligeros y desmontables, fabricados en madera de Bambú. Elegante y funcional diseño.

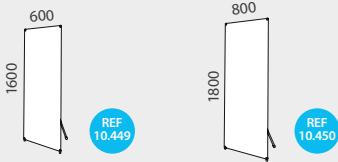

INFORMATION

- 2 sizes available.
- Fast to assemble.
- Carry bag is included.
- Interchangeable graphic.
- Portable and detachable.
- Made of bamboo wood.



BAMBOO 600	QTY	N.W	G.W	C.B.M	SIZE
Packing	40	20kg	22.50kg	0.13	450x270x1130mm
Uni.	1	0.50kg	0.55kg	0.004	105x40x980mm
 10.449	Graphic Size: 600x1600mm				
BAMBOO 800	QTY	N.W	G.W	C.B.M	SIZE
Packing	40	34kg	36kg	0.15	280x450x1180mm
Uni.	1	0.85kg	0.90kg	0.005	105x40x1100mm
 10.450	Graphic Size: 800x1800mm				

BAMBOO X-BANNER



ARBO

more easels available
- see Boards chapter -

adjustable
height

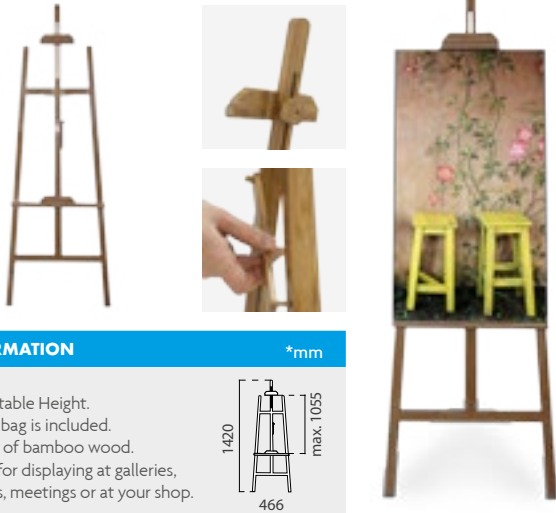

INFORMATION

- Adjustable Height.
- Carry bag is included.
- Made of bamboo wood.
- Ideal for displaying at galleries, events, meetings or at your shop.

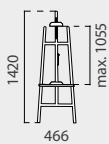

ARBO	QTY	N.W	G.W	C.B.M	SIZE
Packing	6	13kg	15kg	0.41	600x450x1550mm
Uni.	1	2.50kg	3.30kg	0.003	490x40x1425mm
 10.452	Adjustable Height for Canvas: Max. 1055mm				

BAMBOO ROLL UP

bamboo
wood

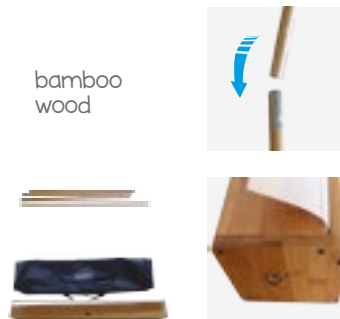

INFORMATION

- Easy to assemble.
- Carry bag is included.
- Interchangeable graphic.
- Portable and retractable.
- Made of bamboo wood.



BAMBOO	QTY	N.W	G.W	C.B.M	SIZE
Packing	4	12.6kg	15.2kg	0.091	350x290x900mm
Uni.	1	3.15kg	3.80kg	0.02	170x140x870mm
 10.444	Graphic Size: 800x2060mm				



SILVES GOLF BANNER

EN Foldable banner, easy installation, ideal for indoor and outdoor events. Available in 3 sizes. Components: Carry bag, hooks, fiberglass pole connectors, fiberglass pole and black fabric of 60mm width.

FR Banner pliable, montage facile, idéal pour des événements d'intérieur ou d'extérieur. Disponible en 3 dimensions. Inclus: Sac de transport, crochets métalliques de fixation, baguette en fibre, connexion pour les baguettes en fibre et textile noir de 60mm de large.

PT Expositor em tecido para exterior. Este sistema permite que uma só pessoa monte o expositor de forma fácil e rápida. Conteúdo: Bolsa de transporte, ganchos metálicos para fixar, uniões para as barras de fibra, barras de fibra e tela preta com 60mm para o rebordo.

ES Banner plegable de fácil montaje ideal para eventos tanto de interior como de exterior. Disponible en 3 tamaños. Componentes: Bolsa de transporte, ganchos metálicos para clavar (piquetas), barras de fibra, conectores y tela negra de 60mm de ancho de borde.

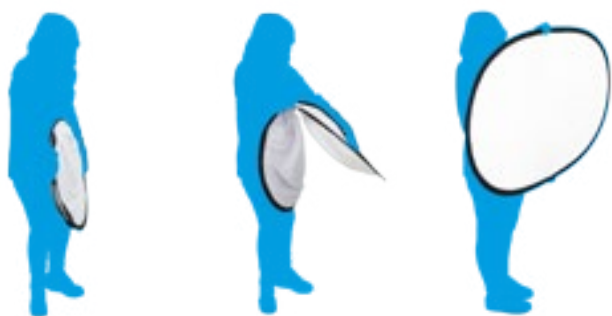

INFORMATION

*mm

- Extremely portable and lightweight.
- Flexible fiberglass providing greater stability and improved performance without the need for any assembly.

- Available in 3 sizes. Carry bag included.
- Ideal for making your message stand out from the crowd at any event either indoors or outdoor.

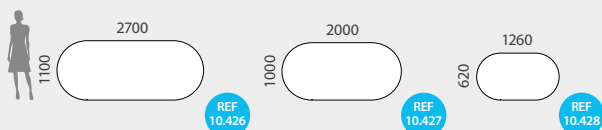

SILVES 1100	QTY	N.W	G.W	C.B.M	SIZE
Packing	5	12.50kg	13kg	0.26	1200x180x1200mm
Uni.	1	2.50kg	2.60kg	0.05	1140x30x1140mm

10.426 Graphic Size: 1100x2700mm

SILVES 1000	QTY	N.W	G.W	C.B.M	SIZE
Packing	5	8.50kg	8.9kg	0.17	960x180x960mm
Uni.	1	0.90kg	1kg	0.045	950x50x950mm

10.427 Graphic Size: 1000x2000mm

SILVES 620	QTY	N.W	G.W	C.B.M	SIZE
Packing	5	7kg	7.25kg	0.08	660x180x660mm
Uni.	1	1.40kg	1.45kg	0.012	640x30x640mm

10.428 Graphic Size: 620x1260mm



OUTDOOR BANNER | Refillable Base Banner



- EN** Outdoor banner stand with water fillable bases, offering impressive single or double-sided graphic displays. Laquered aluminium and plastic parts.
- FR** Support visuel idéal pour l'extérieur. Avec base en plastique à remplir d'eau. Disponible en simple et double face. Fabriqué en aluminium et plastique.
- PT** Banner de exterior com reservatórios na base que se podem encher com água ou areia. Oferece um grande impacto visual tanto em simples como em dupla face.
- ES** Soportes visuales con bases rellenas de agua, ideales para su uso en exteriores. Disponibles a una o doble cara. Fabricados en aluminio lacado y partes de plástico.

- EN** Fiberglass, plastic and laquered aluminium.
- FR** Fibre de verre, plastique et aluminium.
- PT** Fibra de vidro, plástico e alumínio lacado.
- ES** Fibra de vidrio, plástico y aluminio lacado.

INFORMATION

*mm

- Carry bag included.
- Portable | Detachable.
- Refillable with 6l water.
- Easy interchangeable graphic.
- Suitable for indoor or outdoor.
- Fiberglass, lacquered aluminium.

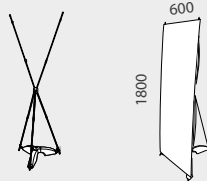

ALMAZAN	QTY	N.W	G.W	C.B.M	SIZE
Pole	1	0.55kg	0.6kg	0.004	80x65x750mm
Base	1	0.95kg	1kg	0.015	250x170x350mm



10.028

Graphic Size: 600x1800mm

ALMAZAN

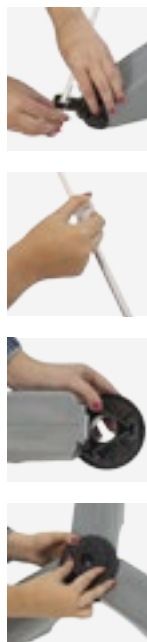

6 L water refillable

- EN** Fiberglass, plastic and laquered aluminium. Adjustable height
- FR** Fibre de verre, plastique et aluminium. Ajustable en hauteur.
- PT** Fibra de vidro, plástico e alumínio lacado. Ajustável em altura.
- ES** Fibra de vidrio, plástico y aluminio lacado. Regulable en altura.

INFORMATION

*mm

- Carry bag included.
- Portable | Detachable.
- Refillable with 6l water.
- Easy interchangeable graphic.
- Adjustable height (telescopic).
- Suitable for indoor or outdoor.
- Fiberglass, lacquered aluminium.

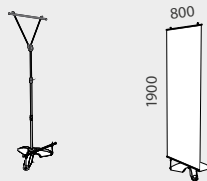

ALMENAR	QTY	N.W	G.W	C.B.M	SIZE
Packing	6	13kg	16.20kg	0.1	400x320x850mm
Uni.	1	1.8kg	2.2kg	0.02	240x100x840mm



10.029

Graphic Size: 800x1900mm

ALMENAR



telescopic



6 L water refillable

OUTDOOR BANNER | Refillable Base Banner

- EN Double-sided. Plastic and laquered aluminium.
- FR Double face. Fabriqué en plastique et aluminium.
- PT Expositor de dupla face. Em plástico e alumínio lacado.
- ES Doble cara. Realizado en plástico y aluminio lacado.





INFORMATION

*mm

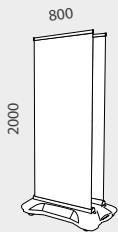
Haro is a detachable double-sided display made of fiberglass and laquered aluminium, with a refillable 56l base which is suitable for indoor and outdoor use. Features a nylon Carry Bag. Place this sidewalk display outdoors in areas with high foot traffic, such as a lobby or outside your business.



HARO	QTY	N.W	G.W	C.B.M	SIZE	
Packing	1	17.7kg	19.6kg	0.17	620x230x1160mm	 
	10.954	Graphic Size: 800x2000mm (x2)				

INFORMATION

*mm

Medinaceli is a detachable poster display with a refillable 12l water plastic base which is suitable for indoor and outdoor use. The change of graphic is simple and takes only a few seconds. Features a nylon Carry Bag for an easy transport and storing. Place this sidewalk display outdoors in areas with high foot traffic, such as a lobby or outside your business. Ideal for displaying at expositions, events, outdoor markets or at tradeshows.

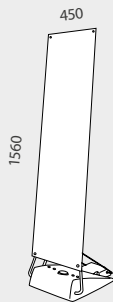



MEDINACELI

fill it with 12 L water

includes carry bag



MEDINACELI	QTY	N.W	G.W	C.B.M	SIZE	
Packing	2	7kg	8.6kg	0.11	540x190x1050mm	 
Uni.	1	2.85kg	3.50kg	0.05	500x100x1030mm	
	10.026	Graphic Size: 450x1560mm				

PANELFIX WING
OUTDOOR



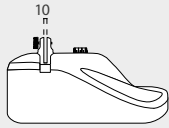



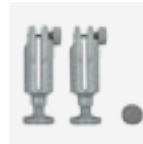

INFORMATION *mm



refillable



With a durable design and easy portability, this double-sided base with corrugated plastic insert is a go to for many marketers and advertisers. Place this sidewalk display outdoors in areas with high foot traffic, such as a lobby or outside your business, to draw in new customers. The weighted poster holder can be filled with up to 5L of water or sand. This base is available on Grey or black color.

PANELFIX WING	QTY	N.W	G.W	C.B.M	SIZE	
Packing	1	2kg	2.55kg	0.04	440x190x520mm	  
 10.442						
 10.443					x2 	

INFORMATION *mm

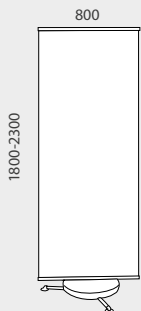



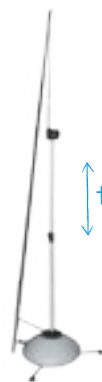

telescopic



Cepeda is a telescopic poster display with a refillable 20l base which is suitable for indoor and outdoor use. The change of graphic is simple and takes only a few seconds. Features a nylon Carry Bag. Place this sidewalk display outdoors in areas with high foot traffic, such as a lobby or outside your business.



CEPEDA	QTY	N.W	G.W	C.B.M	SIZE	
Pole	1	1.5kg	1.7kg	0.01	100x90x1160mm	  
Base	1	2kg	2.25kg	0.05	460x240x470mm	
 10.800	Graphic Size: 800x1800-2300mm					

OUTDOOR BANNER | Refillable Base Banner

Fill each base with 25 L water or sand

BARAHONA

5.6m Width



INFORMATION

*mm

- With 2 Bases (fill each one with 25L water or sand).
- Barahona "1" is ideal as large graphic banner display (one or two-sided) also is perfect for an outdoor use, with bases which can resist strong wind conditions.

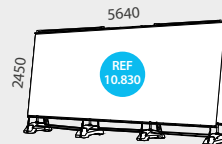
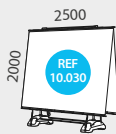

- With 4 Bases (fill each one with 25L of water or sand), Barahona "2" is ideal as large graphics display (1 or 2-sided). Its 4 ultra-large bases are very stable for an outdoor use, which ones are available to resist strong wind conditions. Barahona "2" is the first choice for a huge outdoor display background (visual: 5640x2450mm).

BARAHONA 1	QTY	N.W	G.W	C.B.M	SIZE	
Pole	1	11.5kg	16kg	0.04	410x210x1660mm	 x2 Bases
Base	1	8kg	9kg	0.11	430x310x850mm	
*10.030	Graphic Size: 2500x2000mm					

BARAHONA 2	QTY	N.W	G.W	C.B.M	SIZE	
Pole	1	17.2kg	21.1kg	0.044	170x150x1720mm	 x4 Bases
Base	1	13.30kg	18.3kg	0.12	470x300x850mm	
10.830	Graphic Size: 5640x2450mm					

KIEL



single



double-sided



INFORMATION

*mm

- Refillable 20L water base.
- Telescopic support pole and the central hub allows the adjustment of height. Fast set-up.
- Built for durability and strength, Kiel is ideal for indoor or outdoor promotion, and as it can be used to present a double-sided graphic (ideal for areas with 2-ways traffic). Graphics are held with a simple and fast eyelet system.

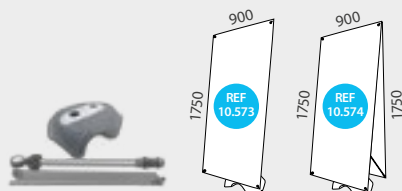

- In the double-sided Kiel 10.574, after the placement of graphs the **distance** to the ground on both sides can differentiate each other: $\pm 50\text{mm}$.

KIEL SINGLE	QTY	N.W	G.W	C.B.M	SIZE
Packing	1	2.8kg	3.25kg	0.09	400x200x1080mm
10.573	Graphic Size: 900x1750mm				

KIEL DOUBLE	QTY	N.W	G.W	C.B.M	SIZE
Packing	1	3kg	3.45kg	0.09	400x200x1080mm
10.574	Graphic Size: 900x1750mm x2				

CHARLEROI

with 2 chain connectors for barrier mounting



double sided



INFORMATION

*mm

- Double sided.
- Fill its base with 4l water/sand.
- It allows the barriers mounting thanks to its 2 chain connections.
- Ideal for indoor or outdoor use like shop entrances, sidewalks gardens, restaurant terraces, etc.

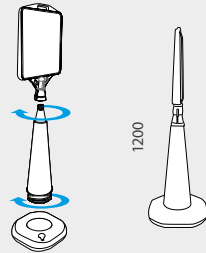

CHARLEROI	QTY	N.W	G.W	C.B.M	SIZE
Packing	1	2kg	2.5kg	0.07	500x200x690mm



10.248 Graphic Size: 330x382mm

DELTA

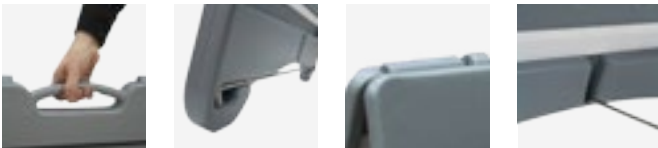

INFORMATION

ARTWORK

*mm

Delta sidewalk double sided board is built with long-lasting plastic to resist rust and other weather-related damage. Able to fit 550x748mm posters with maximum thickness of 5mm. Also the change of graphic is fast and simple thanks its top insert slots. With a carrying handle, Delta folds down quickly for carrying and an easy storage. This indoor and outdoor sidewalk sign is lightweight for transport but large enough to attract attention in any area. Any business can rely on these displays, as the non-slip feet keep them steady on both pavement and bumpy grass. Try this sidewalk sign outside of your store to attract customers and promote yourself effectively. Perfect for any high-traffic area.

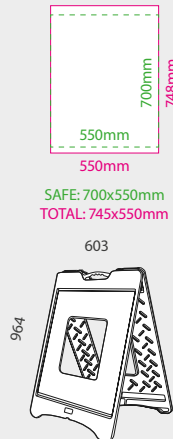

indoor or outdoor use

DELTA	QTY	N.W	G.W	C.B.M	SIZE
Packing	1	7kg	8kg	0.05	630x80x1010mm

10.679 Graphic Size: 550x748mm

OCEAN



INFORMATION

*mm

Resting on a plastic 10l water-refillable base, Ocean outdoor unit is designed for indoor and outdoor use. With an oscillating 620x1000mm board, the advertising options are numerous for your business outdoor sign. Each board is double-sided for twice the promotion. When you need to move the unit, the built-in wheels let you easily reposition to a better location or bring it inside at the end of the work day.

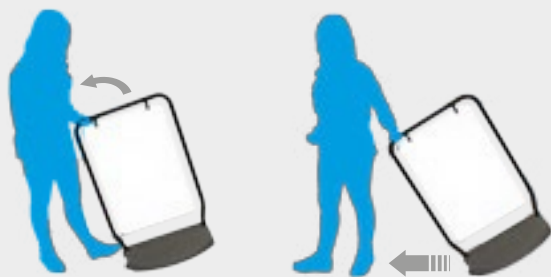
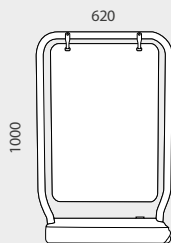

- 1 First, use the foot to tilt the board slightly toward to you.
- 2 Then, move the Ocean Display behind you using its wheels.



OCEAN	QTY	N.W	G.W	C.B.M	SIZE
Packing	1	5.4kg	7.0kg	0.17	1100x140x100mm



10.305 Graphic Size: 500x750mm



OUTDOOR BANNER | Flagpoles



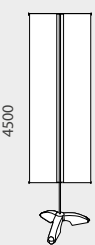

- EN** Outdoor flagpoles with heavy refillable bases which allows a great stability. Made of aluminium and plastic parts. Visible at a great distance.
- FR** Banderoles extérieure en aluminium et base en plastique remplissable d'eau. Permet la visualisation des images à grande distance.
- PT** Mastro de exterior para a colocação de duas imagens. Possui uma base onde se pode colocar água. Fabricado em alumínio e plástico.
- ES** Sistema para banderas de exterior en aluminio con bases de plástico rellenas que proporcionan gran estabilidad. Visibles a larga distancia.

YUSTE 4.5m





INFO	ARTWORK	*mm
		
4500	1500 - ±4500	600

- Telescopic.
- Refillable 6L base.
- Carry bag is included.
- Can be used with two banners.

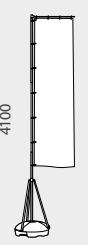

YUSTE	QTY	N.W	G.W	C.B.M	SIZE	
Pole	1	1.35kg	1.85kg	0.015	120x80x1650mm	
Base	1	0.95kg	1.15kg	0.017	260x200x340mm	
10.709	Graphic Size: ± 600x1500-4500mm (x2)					

BREST 4.1m



INFO	ARTWORK	*mm
		
4100	± 2800	800

- Telescopic.
- Carry bag is included.
- Foldable feet structure.
- Refillable 50L heavy base.

BREST	QTY	N.W	G.W	C.B.M	SIZE	
Pole	1	4.1kg	5.1kg	0.029	135x135x1610mm	
Base	1	6kg	6.3kg	0.117	665x265x665mm	
*10.652	Graphic Size: ± 800x2800mm					



improved stability

5m

heavy base



telescopic

76 L of sand/water

INFO ARTWORK *mm

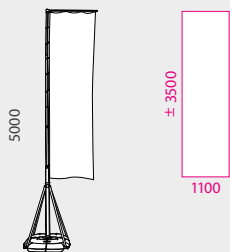

- Telescopic.
- Carry bag is included.
- Foldable feet structure.
- Refillable 76l heavy base.

BEJAR	QTY	N.W	G.W	C.B.M	SIZE	
Pole	1	7.5kg	9.8kg	0.04	160x130x1680mm	
Base	1	10kg	11kg	0.14	430x380x850mm	76 L

* 10.031 Graphic Size: 1100x3500mm

BEJAR



- EN Big Flag dimensions.
- FR Grandes dimensions.
- PT Grandes dimensões.
- ES Grandes dimensiones.

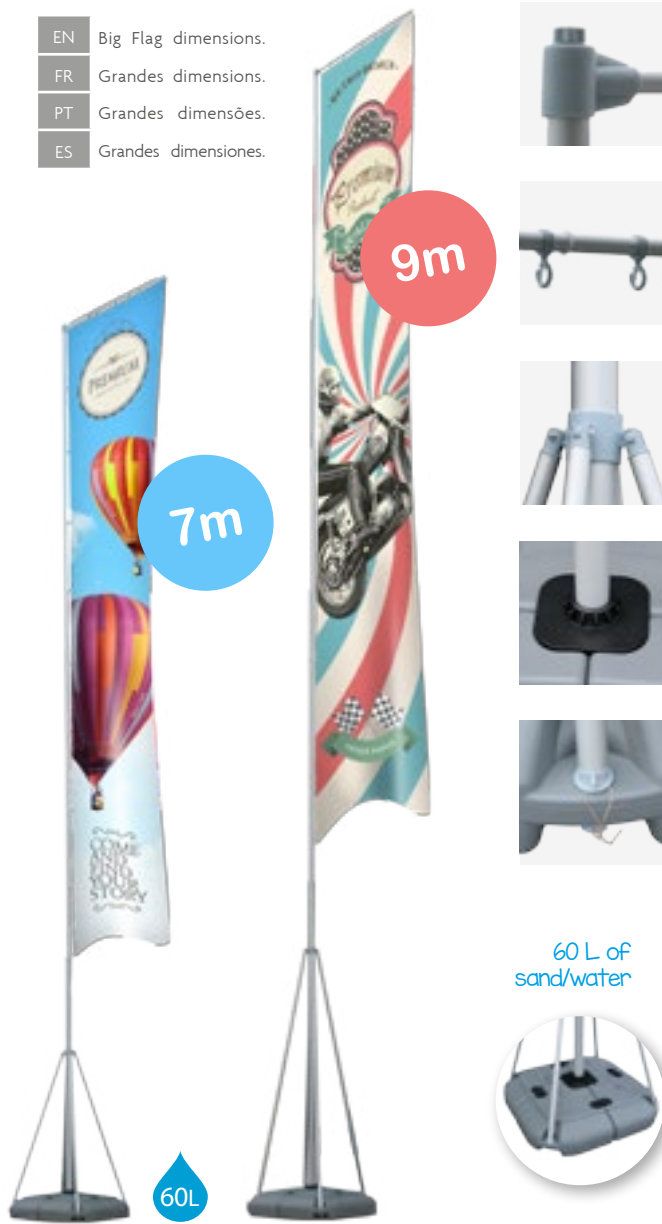

INFORMATION ARTWORK *mm

- Carry bag is included.
- With adjustable height thanks to its telescopic aluminium pole.
- With water Refillable 60 l base.
- For the biggest flags dimensions, with two heights available: 7 or 9m.

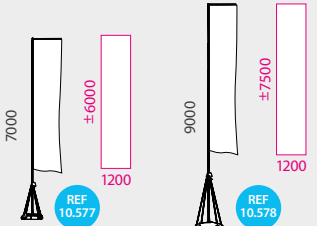

CERGY 6000	QTY	N.W	G.W	C.B.M	SIZE
Pole	1	6.5kg	7.5kg	0.03	150x130x1710mm
Base	1	8kg	9kg	0.13	410x410x805mm

10.577 Graphic Size: ± 1200x6000mm

CERGY 7500	QTY	N.W	G.W	C.B.M	SIZE
Pole	1	8.5kg	9.5kg	0.05	180x170x1710mm
Base	1	14kg	15kg	0.24	510x510x920mm

10.578 Graphic Size: ± 1200x7500mm



SQUARE



ARTWORK *mm

SAFE ZONE
TOTAL GRAPHIC

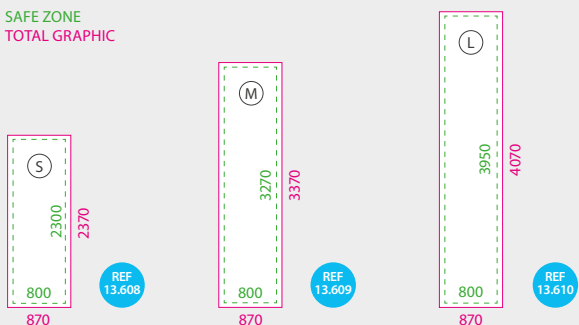

INFORMATION

- Carry bag is included.
- Ideal for promoting at beach.
- Multiple accessories available:



SQUARE S	QTY	N.W	G.W	C.B.M	SIZE
Packing	1	0.94kg	1.44kg	0.004	80x50x1050mm
13.608					S
SQUARE M	QTY	N.W	G.W	C.B.M	SIZE
Packing	1	1.46kg	1.96kg	0.005	100x50x1050mm
13.609					M
SQUARE L	QTY	N.W	G.W	C.B.M	SIZE
Packing	1	1.80kg	2.30kg	0.005	100x50x1050mm
13.610					L



FLYING BANNER	
EN	Flying Banner featuring different bases. The price includes only the pole.
FR	Mât pour drapeaux. Possibilité de choisir parmi plusieurs socles. Prix du mât.
PT	Mastro para exterior que se adapta a diferentes bases. Preço do mastro.
ES	Flying Banner puede combinarse con distintas bases. Precio sólo del poste.

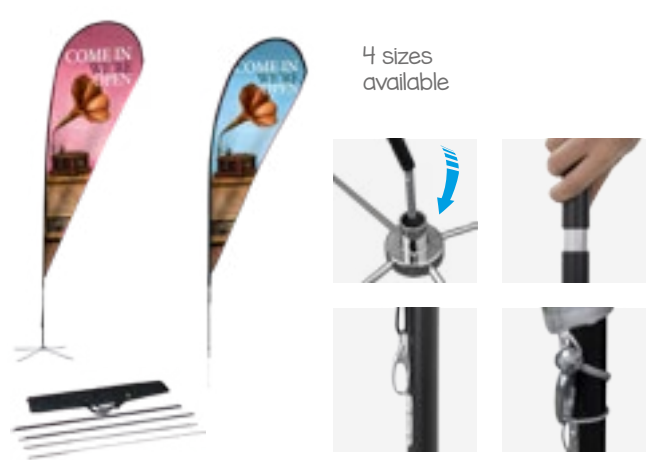

SPOON





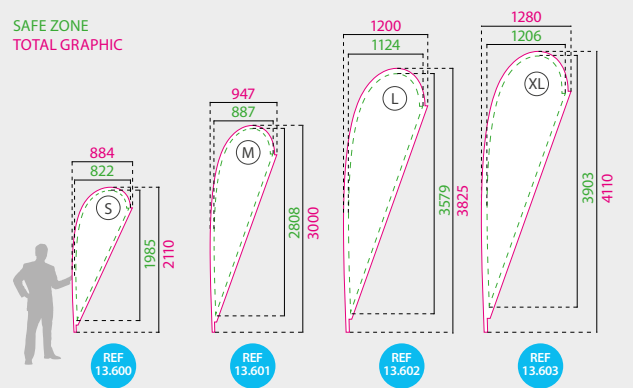





ARTWORK *mm



INFORMATION

- Carry bag is included.
 - Multiple accessories available.
 - Aluminium, fiberglass and plastic.
 - Ideal for using at a variety of events.
- The pole included with this display is collapsible for an easy portability.
-

SPOON S	QTY	N.W	G.W	C.B.M	SIZE
Packing	1	0.67kg	0.72kg	0.004	65x50x1410mm
 13.600					
SPOON M	QTY	N.W	G.W	C.B.M	SIZE
Packing	1	1.07kg	1.57kg	0.005	80x50x1410mm
 13.601					
SPOON L	QTY	N.W	G.W	C.B.M	SIZE
Packing	1	1.49kg	1.99kg	0.005	80x50x1410mm
 13.602					
SPOON XL	QTY	N.W	G.W	C.B.M	SIZE
Packing	1	1.78kg	2.28kg	0.005	80x50x1410mm
 13.603					



KNIFE



ARTWORK

*mm



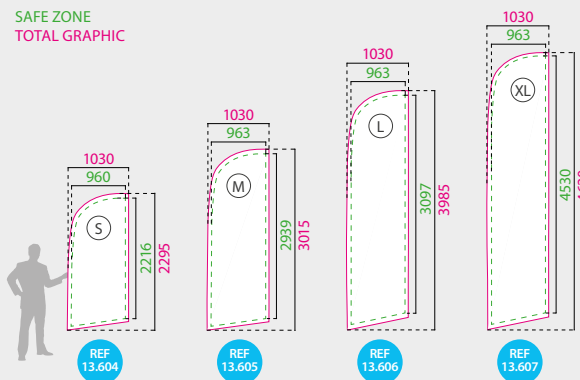



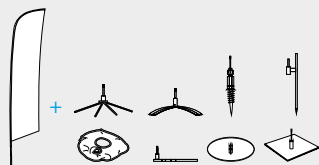

SAFE ZONE
TOTAL GRAPHIC



INFORMATION

- Carry bag is included.
 - Multiple accessories available.
 - Aluminium, fiberglass and plastic.
 - Ideal for using at a variety of events.
- The pole included with this display is collapsible for an easy portability.



KNIFE S	QTY	N.W	G.W	C.B.M	SIZE
Packing	1	0.94kg	1.44kg	0.005	80x50x1410mm
 13.604					
KNIFE M	QTY	N.W	G.W	C.B.M	SIZE
Packing	1	1.15kg	1.65kg	0.005	80x50x1410mm
 13.605					
KNIFE L	QTY	N.W	G.W	C.B.M	SIZE
Packing	1	1.60kg	2.10kg	0.005	80x50x1410mm
 13.606					
KNIFE XL	QTY	N.W	G.W	C.B.M	SIZE
Packing	1	1.65kg	2.15kg	0.006	90x50x1410mm
 13.607					



CROSS BASE WITH WATER PLASTIC BAG

3 L bag included



INFORMATION *mm

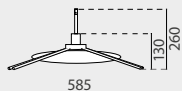

- With 3l refillable bag.
- Ideal for using with the larger flags, also can be used on uneven ground (even on slopes).

CROSS BASE	QTY	N.W	G.W	C.B.M	SIZE
Packing	40	28kg	31kg	0.115	620x460x720mm
Uni.	1	0.7kg	0.77kg	0.025	350x110x590mm

* 13.611

TIRE BASE U STYLE



INFORMATION *mm

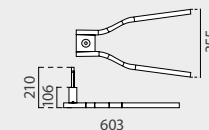

- Fast to assemble.
- Ideal for Installation under car wheel thanks its U shape.

U STYLE	QTY	N.W	G.W	C.B.M	SIZE
Packing	20	34kg	37kg	0.138	540x400x640mm
Uni.	1	1.7kg	1.85kg	0.028	380x120x620mm

* 13.614

WATER PLASTIC BAG



3 L water

INFORMATION



- Great stability.
- Fast to assemble.
- Add an extra 3l weight.
- Suitable for Cross-Plate, Round and Square bases.

WP.BAG	QTY	N.W	G.W	C.B.M	SIZE
Packing	20	3kg	4kg	0.006	200x150x200mm
Uni.	1	0.15kg	0.2kg	0.009	140x40x160mm

* 10.766

ROUND PLATE BASE



INFORMATION *mm

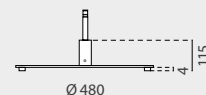

- Great stability.
- Fast to assemble.
- Recommended for an outdoor or indoor use with all Flying Banners.

ROUND	QTY	N.W	G.W	C.B.M	SIZE
Packing	1	8kg	8.5kg	0.014	530x45x590mm

* 13.615

GROUND DRILL

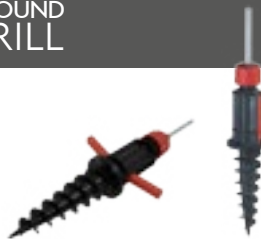

INFORMATION *mm

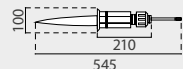

- Fast to assemble.
- For soft grounds, sand or snow. Ideal for displaying at the beach in summer or ski slopes in winter.

DRILL	QTY	N.W	G.W	C.B.M	SIZE
Packing	20	12kg	15kg	0.115	460x410x610mm
Uni.	1	0.6kg	0.75kg	0.025	390x110x590mm

* 13.612

SQUARE PLATE BASE



INFORMATION *mm

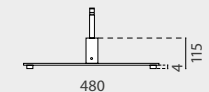

- Great stability.
- Fast to assemble.
- Recommended for an outdoor or indoor use with all Flying Banners.

SQUARE	QTY	N.W	G.W	C.B.M	SIZE
Packing	1	6kg	6.5kg	0.014	530x45x590mm

* 13.616

ROUND STRAIGHT SPIKE

ideal for grass or soft grounds



INFORMATION *mm

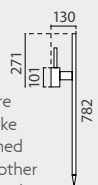

- Fast assembly.
- By the own nature of the ground spike being driven pushed into the grass or other soft grounds, providing a very stable platform.

SPIKE	QTY	N.W	G.W	C.B.M	SIZE
Packing	20	30kg	33kg	0.061	300x225x610mm
Uni.	1	1.5kg	1.65kg	0.009	55x40x590mm

* 13.613

CROSS PLATE BASE



INFORMATION *mm

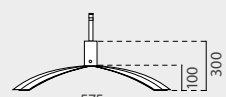

- Great stability.
- Fast to assemble.
- Ideal for concrete surfaces, footpaths or also, for indoor use.

CROSS	QTY	N.W	G.W	C.B.M	SIZE
Packing	5	21.5kg	24kg	0.030	320x120x800mm
Uni.	1	4.3kg	4.8kg	0.005	110x60x780mm

* 13.617

EN Promotional system composed by a lightweight and comfortable backpack and an exhibition structure. Ideal for exhibitions or streetmarketing. With Carry bag.

FR Système portable pour publicité qui comprend un sac à dos confortable et très léger avec une structure publicitaire. Préconisé pour des salons ou street marketing.

PT Sistema transportável para propaganda, composto por uma mochila confortável (e leve) e uma estrutura publicitária. Ideal para feiras/streetmarketing. Com bolsa de transporte.

ES Sistema de promoción portatil compuesto por una mochila ultraligera confortable y una estructura publicitaria, ideal en ferias o streetmarketing. Con bolsa de transporte.

X-BANNER BACKPACK

INFORMATION *mm

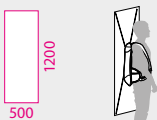

TOTAL GRAPHIC

- Shoulder buckles.
- Soft-Padded for back.
- Side and top pockets.
- Fiberglass X-structure.



X-BANNER	QTY	N.W	G.W	C.B.M	SIZE
Packing	1	1.1kg	1.25kg	0.03	650x100x400mm

 10.760 Graphic Size: 500x1200mm

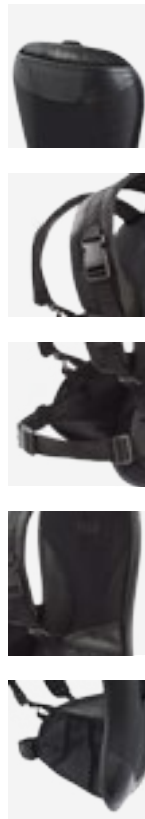

FLAG BANNER BACKPACK

INFORMATION *mm

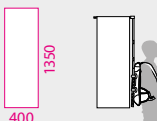

TOTAL GRAPHIC

- Telescopic pole.
- Shoulder buckles.
- Side and top pockets.
- Soft-Padded for back.



FLAG BANNER	QTY	N.W	G.W	C.B.M	SIZE
Packing	1	1.1kg	1.25kg	0.03	650x100x400mm

 10.794 Graphic Size: 400x1350mm

TEARDROP BANNER BACKPACK

INFORMATION *mm

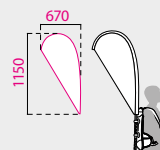

TOTAL GRAPHIC

- With flag tensor.
- Shoulder buckles.
- Soft-Padded for back.
- Side and top pockets.



TEARDROP BANNER	QTY	N.W	G.W	C.B.M	SIZE
Packing	1	1.2kg	1.35kg	0.03	650x100x400mm

 10.795 Graphic Size: 670x1150mm

INDOOR FLYING BANNER | Indoor Flying Banner



- EN** Indoor Flying Banner. You can choose a flying banner base feet covered with an anti-scratch soft velvet finish. The price includes only the pole.
- FR** Drapeaux d'intérieure disponible en 6 modèles différentes. Possibilité d'être utilisé un socle avec finition anti-rayures. Prix seulement du mât.
- PT** Bandeira para interior disponível em 6 modelos diferentes. A base, vendida por separado, tem um revestimento que evita riscos. Preço do mastro.
- ES** Flying Banner de interior. Puede combinarse con una base antideslizante provista de revestimiento anti-arañazos. El precio incluye sólo el poste.

ARTWORK *mm

SAFE ZONE
TOTAL GRAPHIC

INFORMATION

- Fast to assemble.
- Carry bag included.
- Suitable with indoor round base.
- Ideal for supermarkets, shops or indoor promotional events.

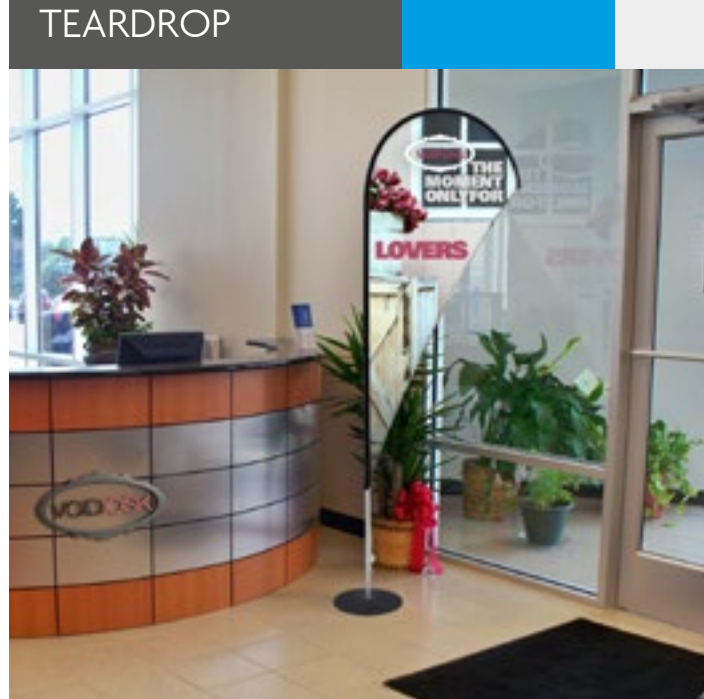
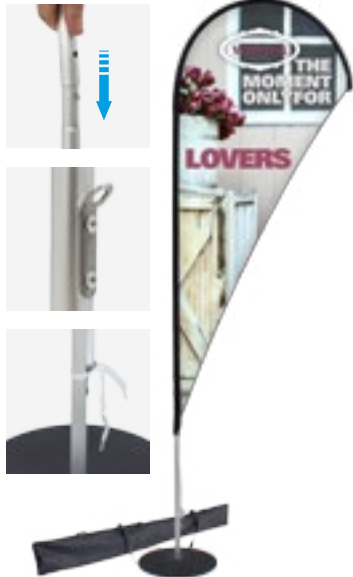

TEARDROP	QTY	N.W	G.W	C.B.M	SIZE
Packing	1	0.50kg	0.65kg	0.0087	145x60x1000mm
	13.621	Graphic: 600x1500mm		Safe: 560x1460mm	

FEATHER

ARTWORK *mm

SAFE ZONE
TOTAL GRAPHIC

INFORMATION

- Fast to assemble.
- Carry bag included.
- Suitable with indoor round base.
- Ideal for supermarkets, shops or indoor promotional events.

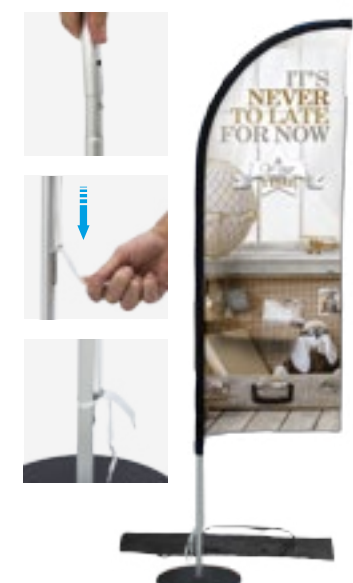

FEATHER	QTY	N.W	G.W	C.B.M	SIZE
Packing	1	0.40kg	0.55kg	0.0087	145x60x1000mm
	13.622	Graphic: 500x1400mm		Safe: 460x1360mm	

SQUARED

ARTWORK *mm

SAFE ZONE
TOTAL GRAPHIC

INFORMATION

- Fast to assemble.
- Carry bag included.
- Suitable with indoor round base.
- Ideal for supermarkets, shops or indoor promotional events.

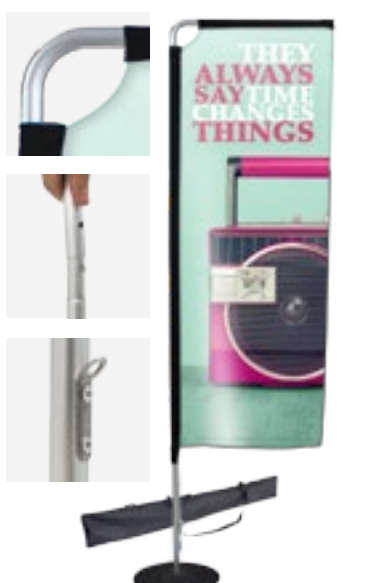

SQUARED	QTY	N.W	G.W	C.B.M	SIZE
Packing	1	0.40kg	0.55kg	0.0087	145x60x1000mm
	13.623	Graphic: 500x1400mm		Safe: 460x1360mm	

SENATOR

ARTWORK *mm

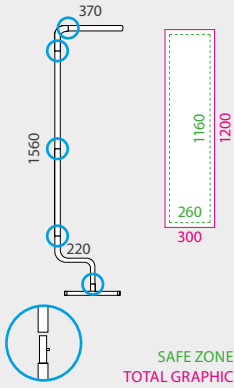

SAFE ZONE
TOTAL GRAPHIC



INFORMATION

- Fast to assemble.
- Counterweight and bag included.
- Suitable with indoor round base.
- Ideal for supermarkets, shops or indoor promotional events.

SENATOR	QTY	N.W	G.W	C.B.M	SIZE
Packing	1	0.45kg	0.60kg	0.0087	145x60x1000mm
 13.624	Graphic: 300x1200mm		Safe: 260x1160mm		

RAZOR

ARTWORK *mm

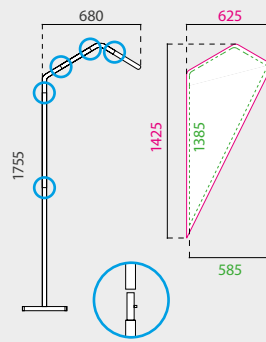

SAFE ZONE
TOTAL GRAPHIC



INFORMATION

- Fast to assemble.
- With carry bag included.
- Suitable with indoor round base.
- Ideal for supermarkets, shops or indoor promotional events.

RAZOR	QTY	N.W	G.W	C.B.M	SIZE
Packing	1	0.45kg	0.60kg	0.0087	145x60x1000mm
 13.625	Graphic: 625x1425mm		Safe: 585x1385mm		

KITE

ARTWORK *mm

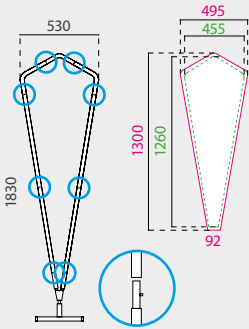

SAFE ZONE
TOTAL GRAPHIC



INFORMATION

- Fast to assemble.
- Carry bag included.
- Suitable with indoor round base.
- Ideal for supermarkets, shops or indoor promotional events.

KITE	QTY	N.W	G.W	C.B.M	SIZE
Packing	1	0.85kg	1.0kg	0.0087	145x60x1000mm
 13.626	Graphic: 495x1300mm		Safe: 455x1260mm		

INDOOR ROUND BASE



2.5mm thickness
anti-scratch finish



INFORMATION



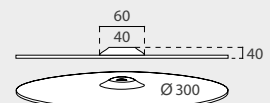





- Made of metal.
- Sided zipped black nylon carry bag with hand-strap included.
- Anti-Scratch finished.

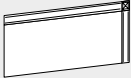

I.ROUND BASE	QTY	N.W	G.W	C.B.M	SIZE
Packing	1	1.10kg	1.20kg	0.00198	315x20x315mm
 13.627	Diameter: Ø 300mm				

- EN Flags made in high quality polyester. Indoor and outdoor suitable.
- FR Drapeaux en polyester de haute qualité pour l'intérieur ou à l'extérieur.
- PT Bandeiras fabricadas em poliéster de alta qualidade. Interior ou exterior.
- ES Banderas de poliéster de alta calidad. Para uso en exterior o interior.

STANDAR FLAGS SYSTEM

STANDARD FLAG FINISHES	FASTENING	FLAG SEWING	
BASIC SEWING	No fastening		Material: Made of Polyester 117g. Flag with basic sewing without fastening.
1	"D" Rings		Material: Made of polyester 117g. Includes three-sided perimeter folding and reinforcement on one side. With two "D" rings for fastening.
2	Carabiners		Material: Made of Polyester 117g. Includes three-sided perimeter folding and reinforcement on one side. With two plastic carabiners for fastening.
3	Eyelets		Material: Made of Polyester 117g. Includes three-sided perimeter folding and reinforcement on one side. With two eyelets for fastening.
4	Cord		Material: Made of Polyester 117g. Includes three-sided perimeter folding and reinforcement on one side. With not elastic cord for fastening.
5	Sheath		Material: Made of Polyester 117g. Includes three-sided perimeter folding with Ø 20mm diameter sheath.
6	"Magic Tape" or Cord		Material: Polyester 117g. Includes three-sided perimeter folding and reinforcement on one side. With "Magic Tape" straps or cord for fastening.
7	Rings / Carabiners		Material: Polyester 117g. Includes three-sided perimeter folding and reinforcement on one side. With rings type "D" or carabiners for fastening.

Standar Flags System

BASIC SEWING

1 2 4 5 7

3

6

10.379	700x1000mm					
10.882	1500x1000mm					
10.883	2000x1200mm					
10.884	2500x1500mm					





C.E



Spain



France



Portugal



Germany



United Kingdom



Sweden



Austria



Belgium



Bulgaria



Cyprus



Czech Republic

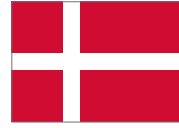

Denmark

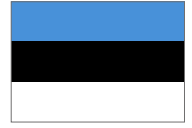

Estonia



Ireland



Italy



Latvia



Lithuania



Luxembourg

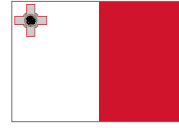

Malta



Finland



Romania



Slovakia



Slovenia



Poland



Greece



Hungary



Netherlands



Afghanistan



Albania



Algeria



Andorra



Argentina



Armenia



Australia



Barbados



Brazil



Cameroon



Canada



Chile



Colombia



Cuba



Ecuador



Egypt



Ethiopia



Guatemala



Haiti



Jamaica



Japan



Mexico



Panama



Qatar



Russia



Switzerland



Ukraine



United Arab Emirates



United States



Uruguay



Uzbekistan



Venezuela



Vietnam



Yemen



Zambia

Internationals



Unicef

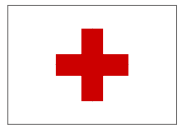

Red Cross

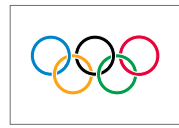

Olimpic Flags



Commonwealth



Autopro



Lannister



WWF

Universities



Uni. Rey Juan Carlos



Harvard



Cambridge

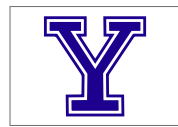

Yale

Sports



Cleveland Cavaliers



Chicago Bears

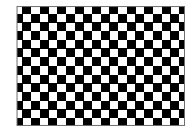

Checkered Flag

Enterprises

WALL BANNER SYSTEM



INFORMATION

*mm

- The profile frame structure is made of silver anodised lightweight aluminium.
- The wall banner system adopts a simple design to showcase your advertisement or promotional poster. Easy to assemble.
- The banner is attached by hanger clips through the grommets and fixed to the aluminium profile structure, allowing a simple and fast changing of the banner.
- Ideal for promoting your business or for displaying at outdoor exhibitions.

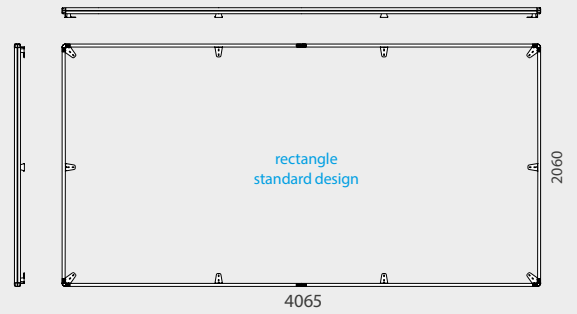
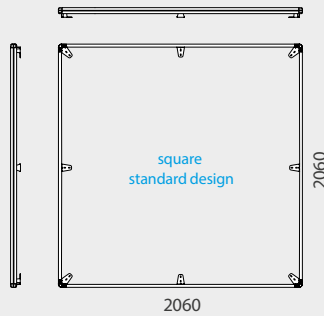



anodised aluminium

lightweight

3m BARS	QTY	N.W	G.W	C.B.M	SIZE
Packing	4	11.77kg	12.80kg	0.048	145x110x3010mm
13.483	Length: 3000mm				x4 

WALL BANNER PROFILE

INFORMATION *mm

- Lightweight.
- Made of anodised aluminium profile.
- Available in 2 or 3m length.

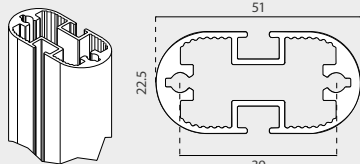

51
22.5
39

13.483
13.484

2m BARS	QTY	N.W	G.W	C.B.M	SIZE
Packing	2	3.92kg	4.40kg	0.0115	75x75x2037mm
13.484	Length: 2000mm				x2 

WALL BANNER CORNER SUPPORT

INFORMATION *mm

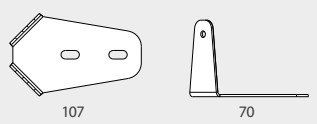

107
70

- 2mm sheet metal.
- Fixing screws included.



CORNER S.	QTY	N.W	G.W	C.B.M	SIZE
Packing	4	0.52kg	0.67kg	0.0021	105x120x165mm
13.485					x4 

WALL BANNER STRAIGHT SUPPORT

INFORMATION *mm

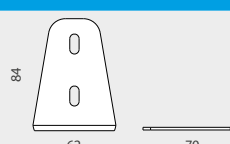

84
62
70

- 2mm sheet metal.
- Fixing screws included.



STRAIGHT S.	QTY	N.W	G.W	C.B.M	SIZE
Packing	4	0.41kg	0.56kg	0.0021	105x120x165mm
13.486					x4 

WALL BANNER CORNER CONNECTION

INFORMATION *mm

- Made of polycarbonate.
- Fixing screws included.
- It allows to connect the aluminium profiles in the corner sections.

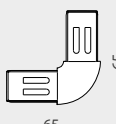

65
65



CORNER C.	QTY	N.W	G.W	C.B.M	SIZE
Packing	8	0.14kg	0.30kg	0.0021	105x120x165mm
13.487					x8 

WALL BANNER PROFILE CONNECTION

INFORMATION *mm

- Made of ABS plastic.
- Fixing screws included.
- It allows to connect the aluminium profiles in the straight sections.



51
85
26



PROFILE C.	QTY	N.W	G.W	C.B.M	SIZE
Packing	4	0.11kg	0.26kg	0.0021	105x120x165mm
13.488					x4 

CANVAS HANGERS

INFORMATION *mm

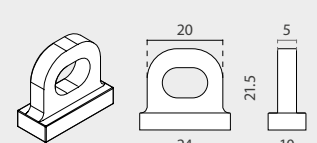

20
5
21.5
10
24

- Made of polycarbonate.
- It allows to hang poster canvas.



13.334					x10 
---------------	--	--	--	--	---

CORNER GRIPS

INFORMATION *mm

- Made of nylon.
- It allows to hang the banner with corners, keeping it perfectly in tension.

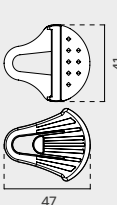

41
47

easy clip-on



16.110					x40 
---------------	--	--	--	--	---



BANNER SUPPORT

EN	Banner flag system for wall, lamps or outdoor posts. Designed for strong wind conditions.	PT	Sistema de bandeirola para parede, postes ou outro sistema de exterior. Desenhado para suportar ventos fortes.
FR	Support drapeaux pour l'extérieur adaptable sur mur ou poteaux. Résiste au vent.	ES	Soporte de gráfica para colocación sobre pared o postes de exterior. Diseñado para resistir condiciones de viento fuerte.

WALL-MOUNTED STREET BANNER POLE



HOSE CLAMPS STREET BANNER POLE

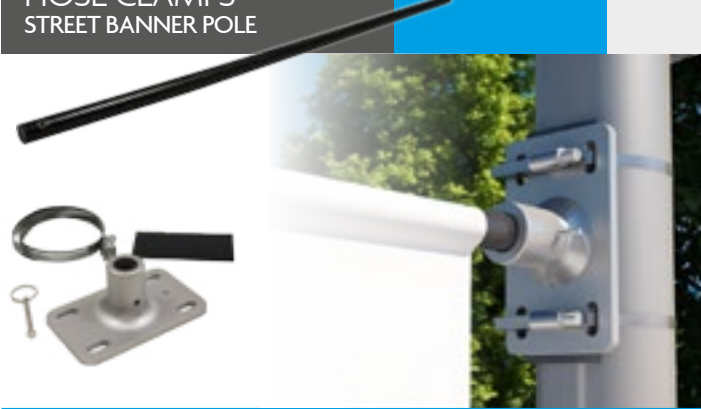

INFORMATION

*mm

- Suitable for wall-mounting.
- Each kit consists of a 19mm diameter pole, 1 metallic bracket, 1 pin with ring and mounting screws.
- Easy and fast banner change by removing the pin connecting the arm to the wall-mounted bracket.

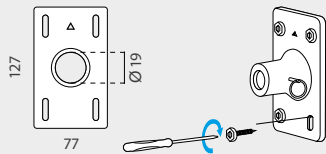

INFORMATION

*mm

- Ideal for outdoor lamps/posts.
- Each kit consists of a Ø19mm pole, 1 metallic bracket, 1 pin with ring and metallic adjustable bands.
- Easy and fast banner change by removing the pin connecting the arm to the outdoor pole bracket.

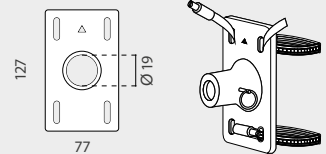

SCREW

* 10.202	Pole 800mm	
* 10.203	Pole 1000mm	
* 10.204	Pole 1200mm	

CLAMPS

* 10.071	Pole 800mm	
* 10.072	Pole 1000mm	
* 10.073	Pole 1200mm	

WALL-MOUNTED STREET BANNER SUPPORT



HOSE CLAMPS STREET BANNER SUPPORT



INFORMATION

*mm

- Suitable for wall-mounting.
- Brackets and mounting screws.
- Ideal for hanging banners of big sizes at promotional acts.

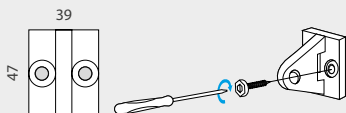

INFORMATION

*mm

- Ideal for outdoor lamps/posts.
- Ideal for hanging banners of big dimensions at outdoor placements.

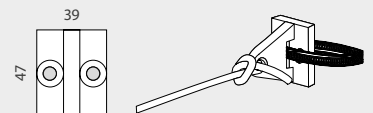

MINI-SCREW





* 10.100	Wall-Mounted	
----------	--------------	--

MINI CLAMPS

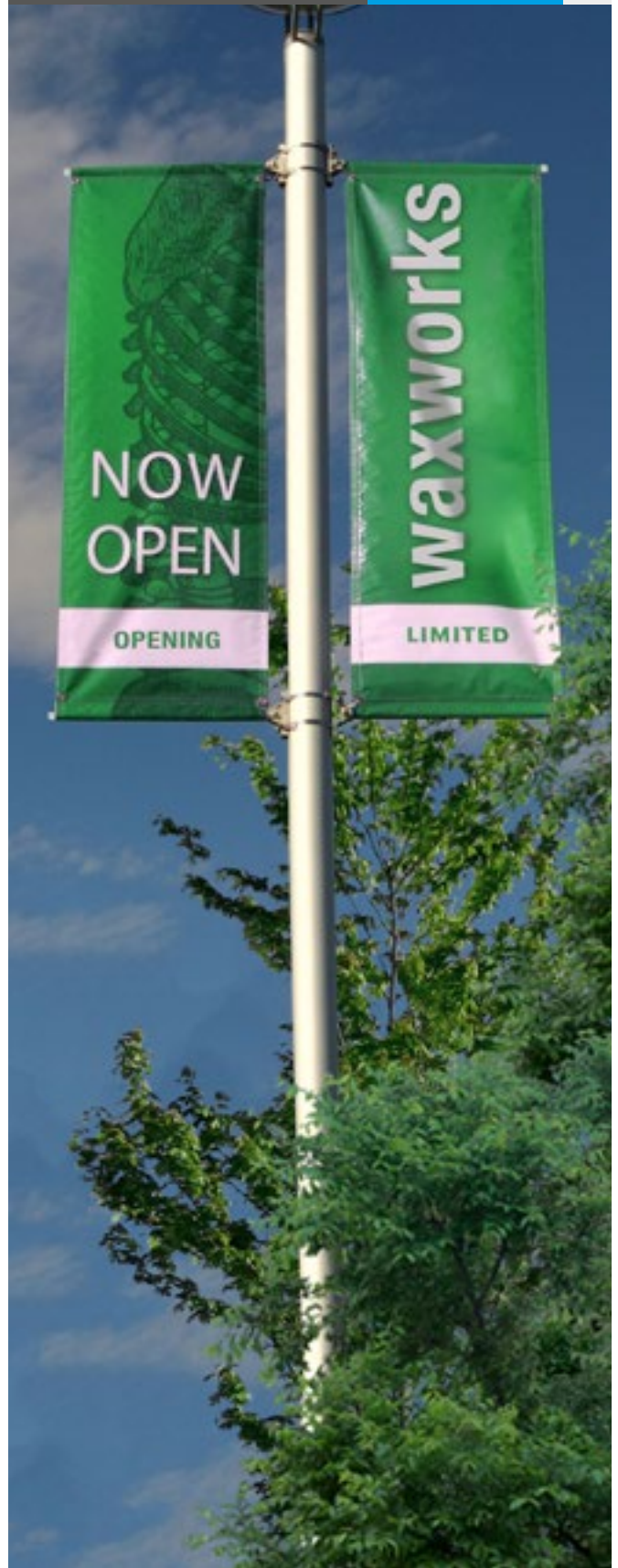
* 10.099	Hose Clamps	
----------	-------------	--

LAMP SYSTEM



EN	<p>Banner flag system for street lamps or another outdoor posts. Designed for strong wind conditions.</p> <ul style="list-style-type: none"> • 2 stainless steel bands. • 1 aluminium bracket. • 1 pin and 1 ring. • 1 fiberglass pole 600 or 1000mm. 	
FR	<p>Potence de rue pour des poteaux à l'extérieur. Conçue pour supporter de forts vents. Inclus:</p> <ul style="list-style-type: none"> • Une pièce d'aluminium pour la fixation au poteau. • Une goupille avec rondelle. • 2 attaches d'acier. • Un poteau en fibre de verre de 600 ou 1000mm. 	
PT	<p>Sistema de bandeirola para postes. Este suporte foi desenhado para suportar ventos fortes. Kit inclui:</p> <ul style="list-style-type: none"> • 1 Suporte. • 2 Abraçadeiras. • Conectores. • 1 Poste de fibra de vidros de 600 ou 1000mm. 	
ES	<p>Soporte para la colocación de material gráfico sobre farolas, mástiles, postes, etc. El kit incluye:</p> <ul style="list-style-type: none"> • 1 Pieza de aluminio para suspensión a poste. • 1 Pasador con 1 anilla. • 2 Abrazaderas de acero. • 1 Poste de fibra de vidrio de 600 o 1000mm. 	

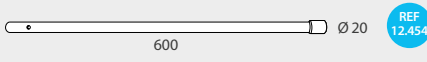
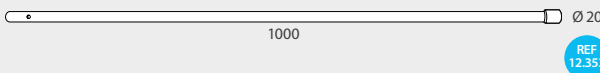

INFORMATION *mm

- Designed for resisting strong wind conditions.

- Aluminium bracket, fiberglass pole, stainless steel bands and plastic parts.

LAMPS. 600	QTY	N.W	G.W	C.B.M	SIZE
Packing	1	0.6kg	1.0kg	0.0039	100x65x610mm
 12.454	Pole 600mm				
LAMPS. 1000	QTY	N.W	G.W	C.B.M	SIZE
Packing	1	1.0kg	1.35kg	0.006	100x65x1010mm
 12.353	Pole 1000mm				

WALL POLE

EN Wall pole is stainless steel anchoring wall system.

FR Système d'ancrage mural en acier inoxydable.

PT Sistema de fixação à parede em aço inoxidável.

ES Sistema de anclaje a pared en acero inoxidable.

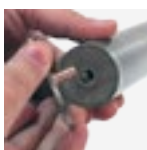

made of stainless steel





wall fixing screws included

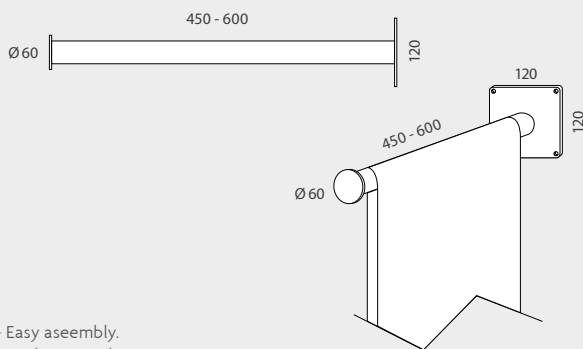

INFORMATION

*mm



- Easy assembly.
- With 60mm diameter cap.
- 2 lengths of pole available.
- Wall fixing screws included.
- Designed for resisting strong weather conditions.
- Easy banner change by removing the connecting cap to the pole bracket.
- The Wall Pole System comprises of a heavy gauge stainless steel pole to which the promotional banner is sleeved and securely mounted to the wall.

POLE 450	QTY	N.W	G.W	C.B.M	SIZE
Packing	2	2.20kg	2.64kg	0.0112	160x130x540mm
 10.453	Pole Size: Ø 40x450mm		x2 		

POLE 600	QTY	N.W	G.W	C.B.M	SIZE
Packing	2	2.46kg	3.00kg	0.0139	160x130x670mm
 10.454	Pole Size: Ø 40x600mm		x2 		





quick and easy magnetic assemble

INFORMATION

*mm

- Double sided.
- Carry bag included.
- Magnetic connections.
- Quick and easy to assemble.
- Big dimensions 3215x2040mm.

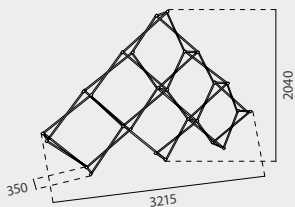

CUMBRE	QTY	N.W	G.W	C.B.M	SIZE
Packing	1	6.2kg	7.7kg	0.05	240x240x840mm
10.423	Structure Size: 3215x2040x350mm				

CUMBRE
POP UP FASHION



double sided

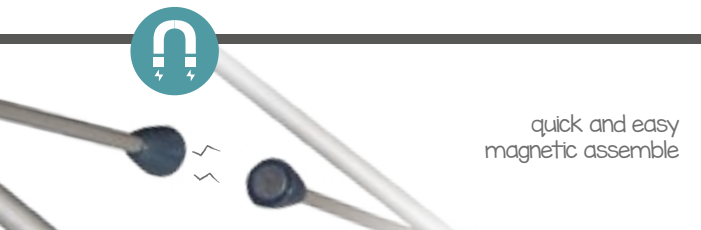

quick and easy magnetic assemble

INFORMATION

*mm

- Magnetic.
- Double sided.
- Carry bag included.
- Ideal for textile printing.
- Stretch-prints gives a 3D effect.



ALIA	QTY	N.W	G.W	C.B.M	SIZE
Uni.	1	5kg	6.5kg	0.03	190x190x830mm
10.424	Structure Size: 2215x770x350mm				

ALIA
POP UP FASHION



double sided

INFORMATION

ARTWORK

*mm

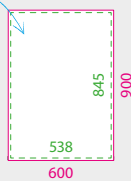
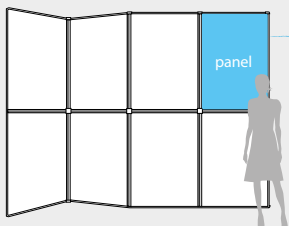

SAFE ZONE
TOTAL GRAPHIC

- 4 folding sections for storage with 8 panels (total one side: 2400x1800mm).
- Arenas fits in nearly any size booth or stand for promoting your business.

- Lightweight to fold effortlessly and disassemble neatly into the included carrying bag for an easy transporting.
- It's ideal as Photocall or wall divider.

ARENAS	QTY	N.W	G.W	C.B.M	SIZE
Packing	1	7.3kg	11kg	0.12	640x200x950mm
10.041	Graphic Size: 2400x1800mm				

ARENAS
EXHIBITION WALL

4 folding panels



grey
RAL
9006

MANAUS BARRIER BANNER

black finished
aluminium



920x2025mm
structure

INFORMATION

ARTWORK *mm

- Lightweight.
- Double-Sided.
- Carry bag included.
- Supplied with stakes.

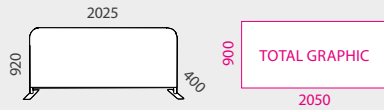

MANAUS	QTY	N.W	G.W	C.B.M	SIZE
Packing	1	5kg	5.2kg	0.04	210x190x1000mm

 10.791 Graphic Size: 2050x900mm



linkable

INFORMATION

*mm

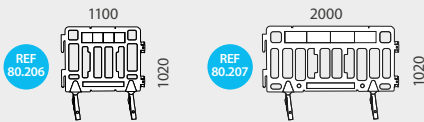

- Ideal for events and exhibitions.
- Linkable. Easily foldable for storage.
- With reflective strip where to place a graph to customize the barrier banner. 1100mm or 2000mm width available.

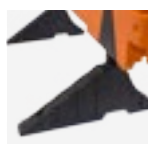

BARRIER 1100	QTY	N.W	G.W	C.B.M	SIZE
Packing	1	8.95kg	9.95kg	0.086	1070x70x1150mm

80.206 External Size: 1100x1020x50mm

BARRIER 2000	QTY	N.W	G.W	C.B.M	SIZE
Packing	1	13kg	14kg	0.153	1070x70x2050mm

80.207 External Size: 2000x1020x50mm

LINKABLE BARRIER BANNER FOR EVENTS



RIO
BARRIER BANNER

900x1850mm
structure



INFORMATION

ARTWORK *mm

- Lightweight.
- Double-Sided.
- Carry bag included.
- Aluminium structure.

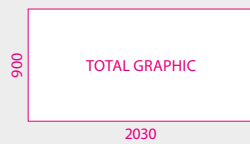
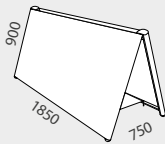

double-sided
aluminium frame

RIO	QTY	N.W	G.W	C.B.M	SIZE
Packing	1	8.8kg	9kg	0.04	210x1900x1000mm
*10.790	Graphic Size: 2030x900mm				

PARANA
BARRIER BANNER



INFORMATION

ARTWORK *mm

- Lightweight.
- Double-Sided.
- Carry bag included.
- Aluminium structure.

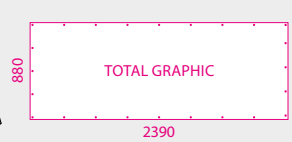
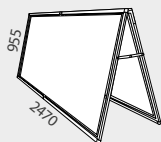

aluminium 955x2470mm
width structure

PARANA	QTY	N.W	G.W	C.B.M	SIZE
Packing	1	7kg	8.1kg	0.049	200x200x1220mm
*10.548	Graphic Size: 2390x880mm				

FABRIC POP UP |



Cangas 3x3 | 4x3

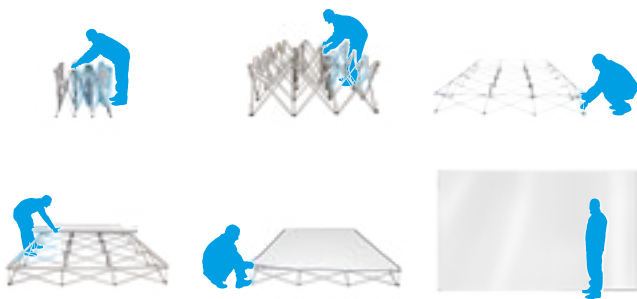

EN

Straight graphic promo for Wall. The graphic can be replaced quickly thanks to its "magic tape". Made of aluminum in silver finishing color.

FR

Mur promotionnel droit. Le visuel peut être changé rapidement grâce à son système "magic tape". Fabriqué en aluminium avec finition couleur argent.

PT

Pop-Up com sistema de "magic tape" que permite a mudança de imagem de forma fácil e rápida. Fabricado em alumínio com acabamento prateado.

ES

Muro promocional recto. La gráfica puede ser sustituida de forma rápida gracias a su sistema "magic tape". En aluminio con acabado en color plata.

CANGAS 3x3 | 4x3 FABRIC POP UP

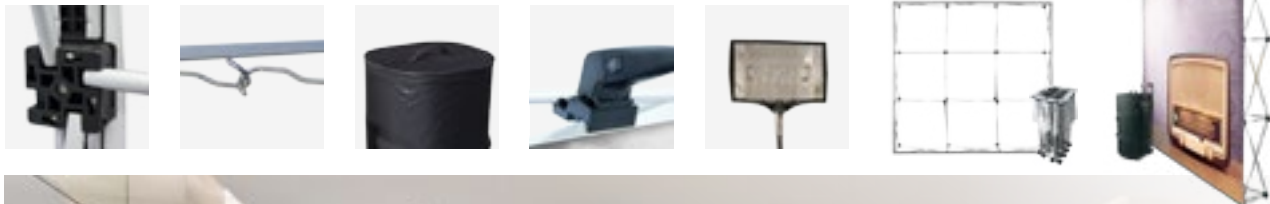

INFORMATION

*mm

Single Sided

Single Sided

REF 10.413

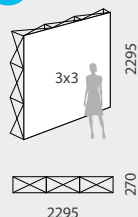

- Available 2 sizes of Cangas Pop-Up.
 - Includes 2 double clamp spotlights.
 - Trolley Carry Bag with wheels included.
 - With 1 roll of "magic tape" included.
 - This straight fabric Pop-Up is one of the most used options for photocalls.
- The graphics are simple to attach using "magic tape" in its perimeter.
- The frame itself is made of aluminium with locking arms for an easy assemble. Ideal for promotional acts, weddings, photocalls or just for displaying at any stand booth on media events.

REF 10.414

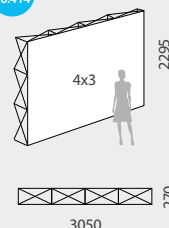

CANGAS 3x3 QTY N.W G.W C.B.M SIZE

CANGAS 4x3 QTY N.W G.W C.B.M SIZE

Packing 1 13.20kg 15kg 0.2 450x450x950mm





Packing 1 16.35kg 17.95kg 0.2 450x450x950mm

10.413 3x3 Graphic Size: 2295x2295mm

10.414 4x3 Graphic Size: 3050x2295mm

CANGAS 5x3 | 6x3 | 7x3 FABRIC POP UP

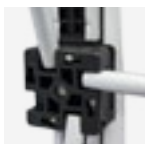
EN	Contains 2 Spotlights.
FR	Inclus 2 Foyers d'éclairage.
PT	Conteúdo 2 Focos de Iluminação.
ES	Contiene 2 Focos de Iluminación.

straight wall



quick and easy



INFORMATION

*mm

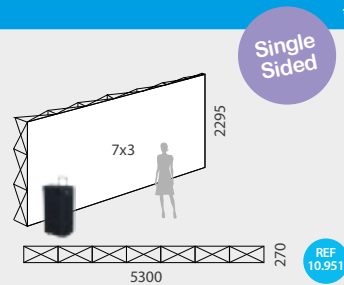
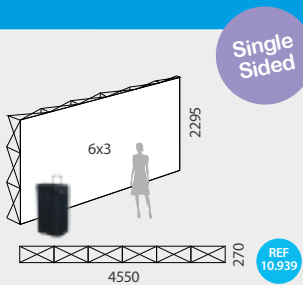
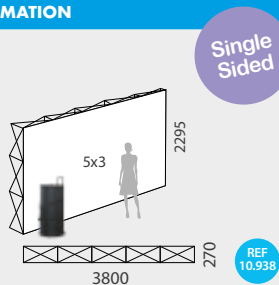

- Available 3 sizes of Cangas Pop-Up. Includes 2 Spotlights, 1 trolley carry bag and 1 roll of "magic tape". This straight fabric Pop-Up is one of the most used options for photocalls. The graphics are simple to attach using "magic tape" in the perimeter of the graphic. The frame itself is made of aluminium with locking arms for an easy assemble. Ideal for promotional acts, weddings, photocalls or just for displaying at any stand booth on media events. The model 10.951 is the biggest (2.3x5.3m) fabric Pop-Up available.

CANGAS 5x3	QTY	N.W	G.W	C.B.M	SIZE		CANGAS 6x3	QTY	N.W	G.W	C.B.M	SIZE		CANGAS 7x3	QTY	N.W	G.W	C.B.M	SIZE				
Packing	1	16.95kg	18.30kg	0.201	460x460x950mm		Packing	1	20.50kg	21.90kg	0.201	540x400x950mm		Packing	1	22.65kg	24.50kg	0.201	540x400x950mm				
10.938		5x3 Graphic Size: 3800x2295mm						10.939		6x3 Graphic Size: 4550x2295mm						10.951		7x3 Graphic Size: 5300x2295mm					

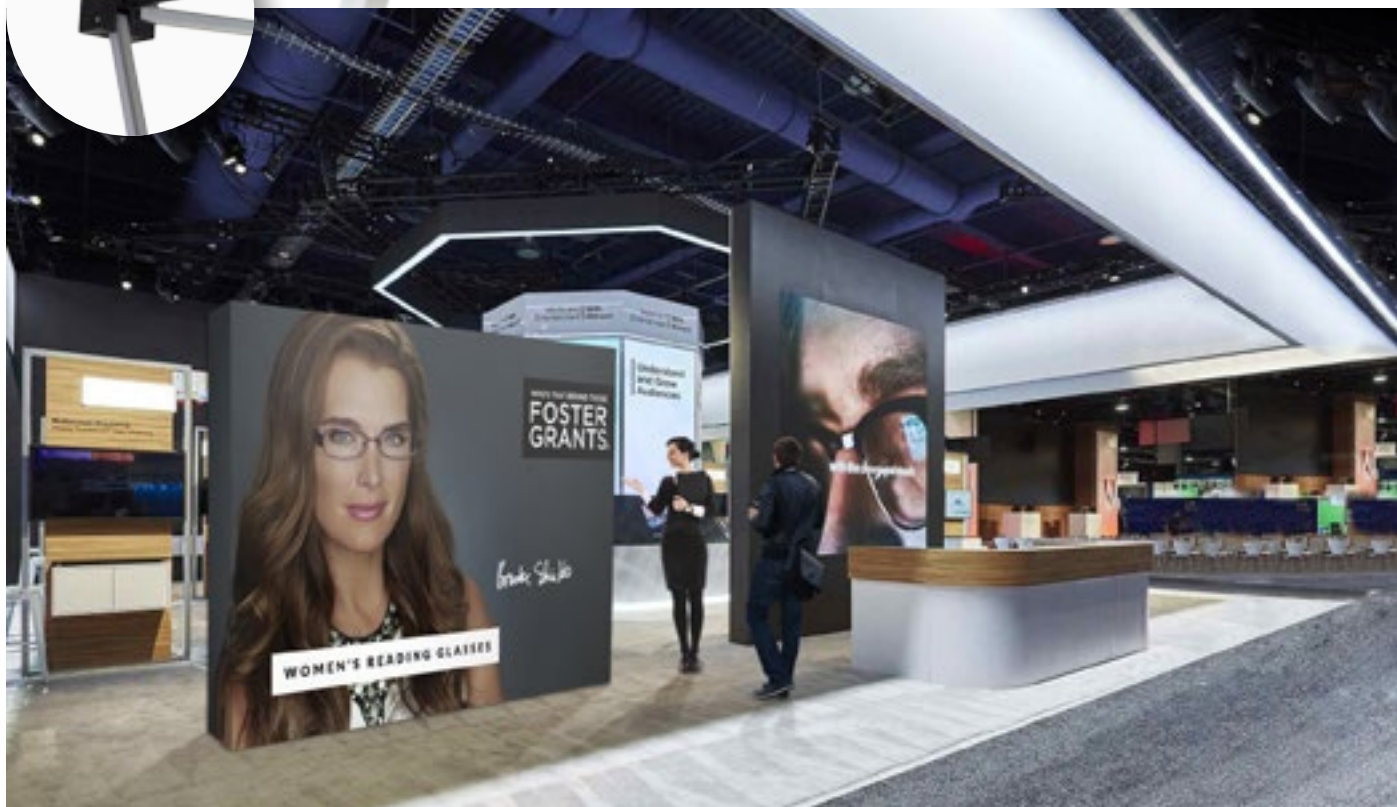

INFORMATION

*mm

Single Sided

Single Sided

REF 13.575

REF 13.576

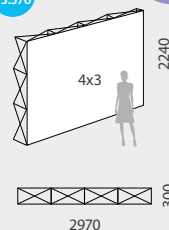
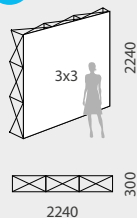

- With the possibility to fix the graph in the sides of the PopUp (consult the size of the graphics in these cases).
- Includes 1 soft-case nylon carry bag.
- With 1 roll of "magic tape" for attachment.
- Surat series feature leveling feet for a suitable adjustment of the PopUp on the surface of the floor.

SURAT 3X3	QTY	N.W	G.W	C.B.M	SIZE
Packing	1	9kg	10kg	0.0597	850x260x270mm
13.575	3x3 Graphic Front: 2240x2240mm 3x3 Graphic Front + Graphic Sides: 2940x2240mm				

SURAT 4X3	QTY	N.W	G.W	C.B.M	SIZE
Packing	1	11kg	12kg	0.0707	850x260x320mm
13.576	4x3 Graphic Front: 2970x2240mm 4x3 Graphic Front + Graphic Sides: 3670x2240mm				

SURAT 5x3
FABRIC POP UP

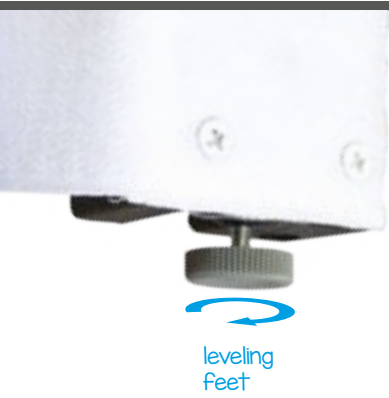

optional spotlight
- sold apart -



quick
and easy

+Sides
Option

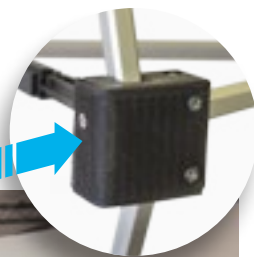

INFORMATION

*mm

REF
13.577

Single
Sided

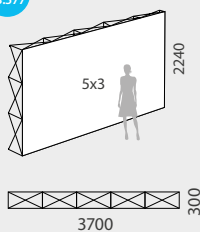

- This is the third size of Surat series.
- These Surat fabric Pop-Up is one of the most used options for photocalls. The graphics are simple to attach using the "magic tape" in the perimeter.
- Remember to check the chart size if you decide to use the sides option. The frame itself is made of aluminium with locking arms for an easy assemble. Ideal for promotional acts, weddings, for photocalls or at any stand booth.

SURAT 5X3	QTY	N.W	G.W	C.B.M	SIZE
Packing	1	13kg	14kg	0.0774	850x260x350mm
13.577	5x3 Graphic Front: 3700x2240mm 5x3 Graphic Front + Graphic Sides: 4440x2240mm				



10.368

optional spotlight
- sold apart *

IPANEMA 3x3 | 4x3
FABRIC POP UP



INFORMATION

*mm

Single Sided

REF 10.792

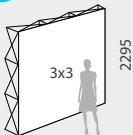

2295

270

2295

- Available 2 sizes of Ipanema Pop-Up.
- Includes 1 soft-case nylon carry bag.
- With 1 roll of "magic tape" for attachment.
- This straight fabric Pop-Up is one of the most used options for photocalls. The graphics are simple to attach using "magic tape" in its perimeter. The frame itself is made of aluminium with locking arms for an easy assemble. Ideal for promotional acts, weddings, for photocalls or at any tand booth.

Single Sided

REF 10.793

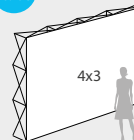

2295

270

3050

IPANEMA 3x3	QTY	N.W	G.W	C.B.M	SIZE
Packing	1	7.65kg	8.35kg	0.06	855x235x280mm
10.792		3x3 Graphic Size: 2295x2295mm			

IPANEMA 4x3	QTY	N.W	G.W	C.B.M	SIZE
Packing	1	8.65kg	9.35kg	0.06	855x235x280mm
10.793		4x3 Graphic Size: 3050x2295mm			

POP UP | Arevalo 2x3 | 3x2



EN Straight or curved promotional wall. The graphic can be replaced quickly thanks to its magnetic system. Made of aluminum. The hard case trolley bag can be used as a counter.

FR Mur promotionnel droit ou courbé. Le visuel peut être changé rapidement grâce à son système magnétique. Fabriqué en aluminium. Valise rigide type trolley peut être utilisé comme compteur.

PT Painel promocional recto ou curvo. Com fecho que permite a mudança de imagem de forma fácil e rápida. Fabricado em alumínio. Mala de transporte tipo carinho pode ser utilizado como balcão.

ES Muro promocional con estructura de aluminio recta o curva. La gráfica puede remplazarse de forma rápida gracias a su sistema magnético. La maleta rígida tipo trolley puede ser empleada como mostrador.

EN Hard case with wheels included.
FR Inclus valise rigide avec roulette.

PT Inclui mala rígida com rodas.
ES Incluye maleta rígida con ruedas.

AREVALO 2x3 | 3x2 VERTICAL & HORIZONTAL

2x3



straight wall



simple transportation

3x2



straight wall

INFORMATION

Single Sided

Single Sided

*mm

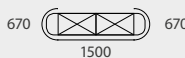
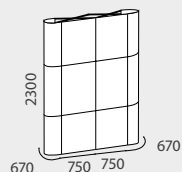

REF 10.369

- Includes 2 Spotlights for accenting your graphics.
- The **trolley hard-case with wheels can be used as a counter.**
- Wrap for the case can be customized with a printed graphic.
- With 1 roll of magnetic strip for attachment of the graphics.
- The magnetic Pop Up is ideal for enhancing your business's presence at your next media event, exhibition, tradeshow, convention or exposition. The "pop up displays", also known as exhibition booths feature a straight or curved brushed aluminum frame that is lightweight, yet sturdy. Custom graphics are attached to the frame with magnetic loop strips (yet with adhesive to the magnetic strip). The entire portable display can be set up and taken down in only a few minutes.

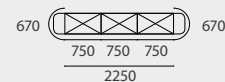
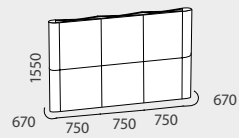

REF 10.425

AREVALO V	QTY	N.W	G.W	C.B.M	SIZE
Packing	1	29.4kg	32.6kg	0.32	730x430x1010mm
REF 10.369	Graphic Size:		670x2300mm x2 750x2300mm x2		

AREVALO H	QTY	N.W	G.W	C.B.M	SIZE
Packing	1	28.8kg	32kg	0.32	720x430x1010mm
REF 10.425	Graphic Size:		670x1550mm x2 750x1550mm x3		

POP UP | Pop Up Laredo

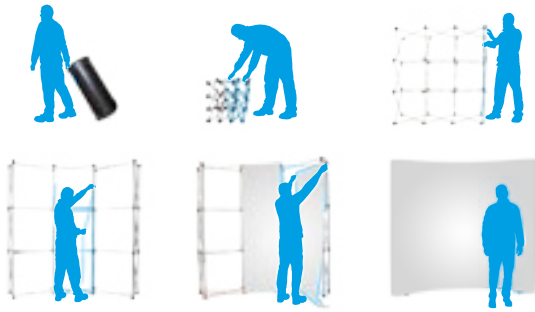

EN Straight or curved promotional wall. The graphic can be replaced quickly thanks to its magnetic system. Made of aluminum.

FR Mur promotionnel droit ou courbé. Le visuel peut être changé rapidement grâce à son système magnétique. Fabriqué en aluminium.

PT Painel promocional recto ou curvo. Com fecho que permite a mudança de imagem de forma fácil e rápida. Fabricado em alumínio.

ES Muro promocional con estructura de aluminio recta o curva. La gráfica puede remplazarse de forma rápida gracias a su sistema magnético.

LAREDO 3x3 STRAIGHT & CURVED

straight wall



simple transportation

curved wall



easy storage

INFORMATION

Single Sided

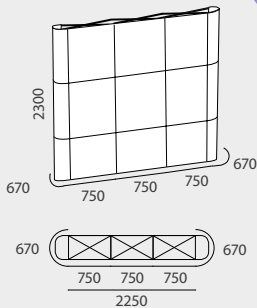

REF 10.520

- Includes 2 Spotlights for accenting your graphics.
- Available on straight wall or curved wall structure.
- Includes 1 nylon trolley carry bag (not counter) with wheels.
- With 1 roll of magnetic strip for attachment of the graphics.
- The magnetic Pop Up is ideal for enhancing your business's presence at your next media event, exhibition, tradeshow, convention or exposition. The "Pop Up displays", also known as exhibition booths feature a straight or curved brushed aluminum frame that is lightweight, yet sturdy. Custom graphics attach to the frame with magnetic loop strips (yet with adhesive to the magnetic strip). The entire portable display can be set up and taken down in only a few minutes.

Single Sided

*mm

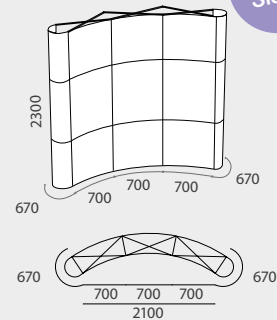

REF 10.547

LAREDO S	QTY	N.W	G.W	C.B.M	SIZE
Packing	1	17.15kg	18.6kg	0.12	390x340x920mm
REF 10.520	Graphic Size:		670x2300mm x2 750x2300mm x3		

LAREDO C	QTY	N.W	G.W	C.B.M	SIZE
Packing	1	17.15kg	18.6kg	0.12	390x340x920mm
REF 10.547	Graphic Size:		670x2300mm x2 700x2300mm x3		

LLANES 4x3 STRAIGHT & CURVED

EN	Contains 2 Spotlights.
FR	Inclus 2 Foyers d'éclairage.
PT	Conteúdo 2 Focos de Iluminação.
ES	Contiene 2 Focos de Iluminación.

easy
installation

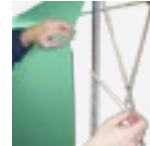
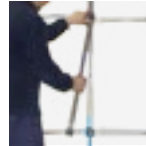

straight wall



curved wall

INFORMATION

Single
Sided

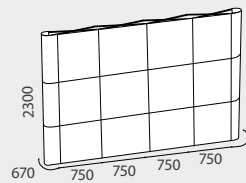

670

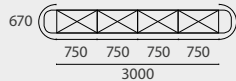

670

REF
10.513

- Includes 2 Spotlights for accenting your graphics.
- Available on straight wall or curved wall structure.
- With 1 nylon trolley carry bag (not counter) with wheels.
- With 1 roll of magnetic strip for attachment of the graphics.
- The magnetic Pop Up is ideal for enhancing your business's presence at your next media event, exhibition, tradeshow, convention or exposition. The "Pop Up displays", also known as exhibition booths feature a straight or curved brushed aluminum frame that is lightweight, yet sturdy. Custom graphics attach to the frame with magnetic loop strips (yet with adhesive to the magnetic strip). The entire portable display can be set up and taken down in only a few minutes.

Single
Sided

*mm

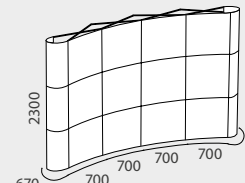

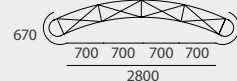

670



670

REF
10.519

LLANES S	QTY	N.W	G.W	C.B.M	SIZE
Packing	1	21.7kg	22.1kg	0.12	390x340x920mm
 10.513	Graphic Size:		670x2300mm x2 750x2300mm x4		

LLANES C	QTY	N.W	G.W	C.B.M	SIZE
Packing	1	21.7kg	22.1kg	0.12	390x340x920mm
 10.519	Graphic Size:		670x2300mm x2 700x2300mm x4		

EN Hard case with wheels included.
FR Inclus valise rigide avec roulette.

PT Inclui mala rígida com rodas.
ES Incluye maleta rígida con ruedas.

GREDOS 3x3 STRAIGHT



straight wall

single or double-sided

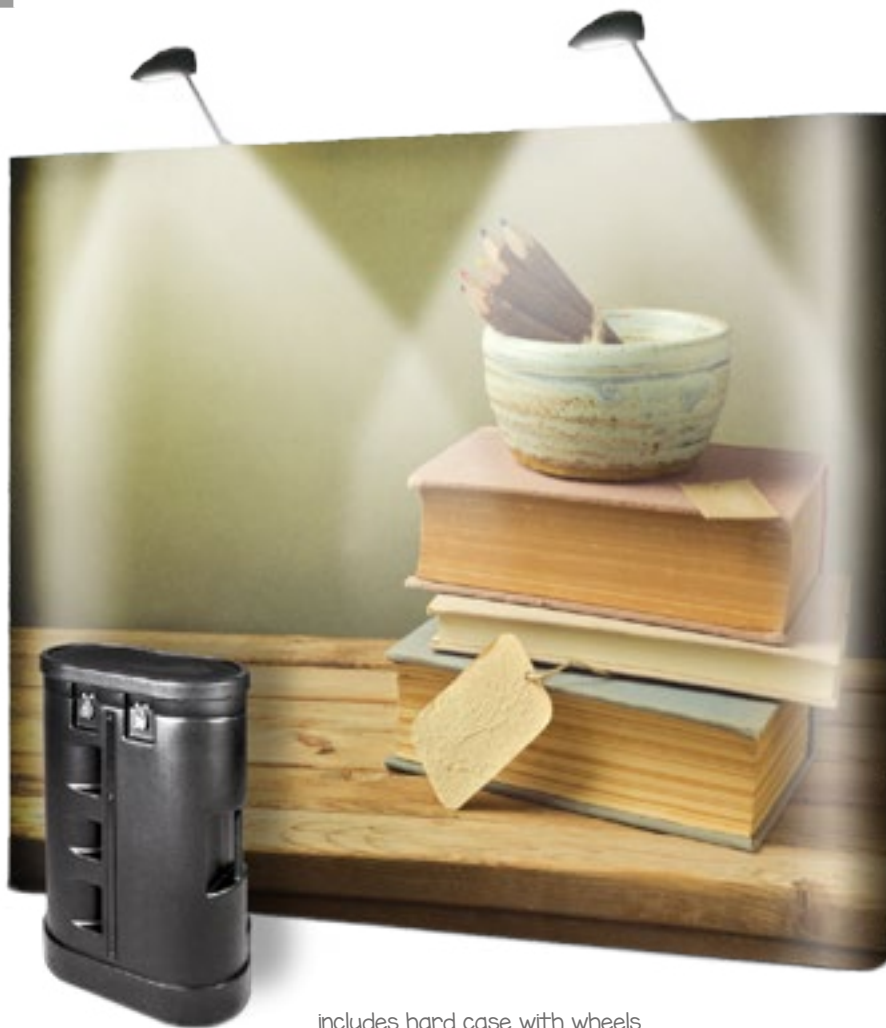

includes hard case with wheels

INFORMATION

*mm

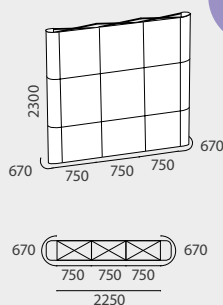

Single Sided

- Includes 2 Spotlights for accenting your graphics.
- The **trolley hard-case with wheels can be used as a counter**.
- Wrap for the case can be customized with a printed graphic.
- With 1 roll of magnetic strip for attachment of the graphics.
- The magnetic Pop Up is ideal for enhancing your business's presence at your next media event, exhibition, tradeshow, convention or exposition. The "pop up displays", also known as exhibition booths feature a straight or curved brushed aluminum frame that is lightweight, yet sturdy. Custom graphics are attached to the frame with magnetic loop strips (yet with adhesive to the magnetic strip). The entire portable display can be set up and taken down in only a few minutes.

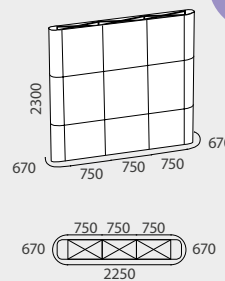

Double Sided

REF 10.366

REF 10.397

GREDOS S1	QTY	N.W	G.W	C.B.M	SIZE
Packing	1	32.25kg	35.45kg	0.32	730x430x1010mm
 10.366	Graphic Size: 670x2300mm x2		750x2300mm x3		

GREDOS S2	QTY	N.W	G.W	C.B.M	SIZE
Packing	1	34.75kg	37.95kg	0.32	730x430x1010mm
 10.397	Graphic Size: 670x2300mm x2		750x2300mm x6		

EN Hard case with wheels included.
 FR Inclus valise rigide avec roulette.
 PT Incluí mala rígida com rodas.
 ES Incluye maleta rígida con ruedas.



GREDOS 3x3 CURVED

single or double-sided

easy storage



INFORMATION

*mm

Single Sided

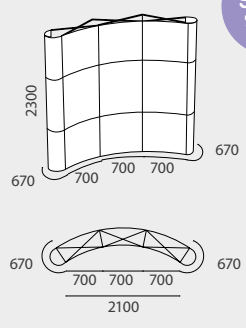

- Includes 2 Spotlights for accenting your graphics.
- The [trolley hard-case with wheels](#).
- With 1 roll of magnetic strip for attachment of the graphics.
- The magnetic Pop Up is ideal for enhancing your business's presence at your next media event, exhibition, tradeshow, convention or exposition. The "pop up displays", also known as exhibition booths feature a straight or curved brushed aluminum frame that is lightweight, yet sturdy. Custom graphics are attached to the frame with magnetic loop strips (yet with adhesive to the magnetic strip). The entire portable display can be set up and taken down in only a few minutes.

Double Sided

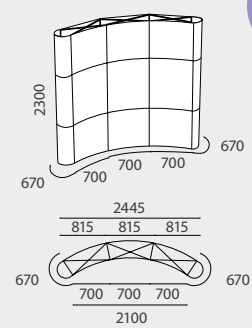

GREDOS C1	QTY	N.W	G.W	C.B.M	SIZE
Packing	1	32.25kg	35.45kg	0.32	730x430x1010mm
10.367	Graphic Size:		670x2300mm x2 700x2300mm x3		

GREDOS C2	QTY	N.W	G.W	C.B.M	SIZE
Packing	1	34.75kg	37.95kg	0.32	730x430x1010mm
10.398	Graphic Size:		670x2300mm x2 700x2300mm x3 815x2300mm x3		

- EN Hard case with wheels included.
- FR Inclus valise rigide avec roulette.
- PT Incluí mala rígida com rodas.
- ES Incluye maleta rígida con ruedas.



MADRIGAL 4x3 STRAIGHT



single or double-sided



*optional Table Top (sold apart)

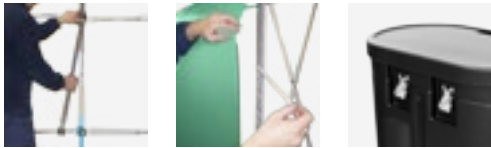

INFORMATION

Single Sided

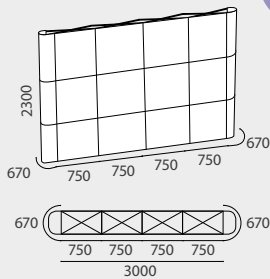

REF 10.036

- Includes 2 Spotlights for accenting your graphics.
- The [trolley hard-case with wheels can be used as a counter](#).
- Wrap for the case can be customized with a printed graphic.
- With 1 roll of magnetic strip for attachment of the graphics.
- The magnetic Pop Up is ideal for enhancing your business's presence at your next media event, exhibition, tradeshow, convention or exposition. The "pop up displays", also known as exhibition booths feature a straight or curved brushed aluminum frame that is lightweight, yet sturdy. Custom graphics are attached to the frame with magnetic loop strips (yet with adhesive to the magnetic strip). The entire portable display can be set up and taken down in only a few minutes.

Double Sided

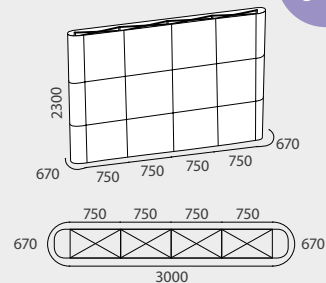

REF 10.857

MADRIGAL S1	QTY	N.W	G.W	C.B.M	SIZE
Packing	1	36.3kg	39.5kg	0.32	730x430x1010mm

❁ 10.036 Graphic Size: 670x2300mm x2
750x2300mm x4

MADRIGAL S2	QTY	N.W	G.W	C.B.M	SIZE
Packing	1	44.5kg	47.7kg	0.32	730x430x1010mm

❁ 10.857 Graphic Size: 670x2300mm x2
750x2300mm x8

MADRIGAL 4x3 CURVED

EN Hard case with wheels included.

PT Inclui mala rígida com rodas.

FR Inclus valise rigide avec roulette.

ES Incluye maleta rígida con ruedas.



single or double-sided

curved wall



includes hard case with wheels

INFORMATION

*mm

Single Sided

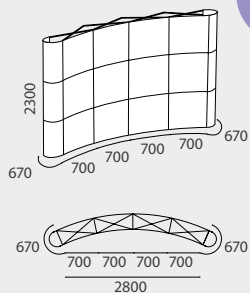

REF 10.037

- Includes 2 Spotlights for accenting your graphics.
- The **trolley hard-case with wheels can be used as a counter**.
- Wrap for the case can be customized with a printed graphic.
- With 1 roll of magnetic strip for attachment of the graphics.
- The magnetic Pop Up is ideal for enhancing your business's presence at your next media event, exhibition, tradeshow, convention or exposition. The "pop up displays", also known as exhibition booths feature a straight or curved brushed aluminum frame that is lightweight, yet sturdy. Custom graphics are attached to the frame with magnetic loop strips (yet with adhesive to the magnetic strip). The entire portable display can be set up and taken down in only a few minutes.

Double Sided

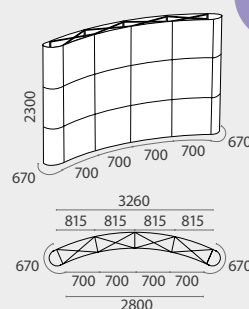

REF 10.400

MADRIGAL C1	QTY	N.W	G.W	C.B.M	SIZE
Packing	1	36.3kg	39.5kg	0.32	710x430x1010mm
 10.037	Graphic Size:		670x2300mm x2 700x2300mm x4		

MADRIGAL C2	QTY	N.W	G.W	C.B.M	SIZE
Packing	1	44.5kg	47.7kg	0.32	710x430x1010mm
 10.400	Graphic Size:		670x2300mm x2 700x2300mm x4 815x2300mm x4		

EN Hard case with wheels included.
FR Inclus valise rigide avec roulette.

PT Inclui mala rígida com rodas.
ES Incluye maleta rígida con ruedas.

NAZARE 5x3
STRAIGHT & CURVED

straight or
curved wall



includes hard case with wheels

INFORMATION

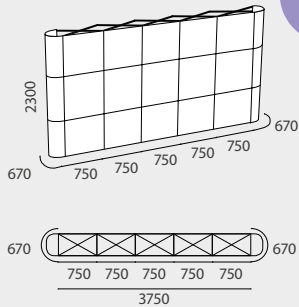

Single Sided

REF 10.236

- Includes 2 Spotlights for accenting your graphics.
- The **trolley hard-case with wheels can be used as a counter**.
- Wrap for the case can be customized with a printed graphic.
- With 1 roll of magnetic strip for attachment of the graphics.
- The magnetic Pop Up is ideal for enhancing your business's presence at your next media event, exhibition, tradeshow, convention or exposition. The "pop up displays", also known as exhibition booths feature a straight or curved brushed aluminum frame that is lightweight, yet sturdy. Custom graphics are attached to the frame with magnetic loop strips (yet with adhesive to the magnetic strip). The entire portable display can be set up and taken down in only a few minutes.

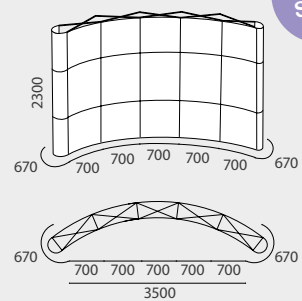

Single Sided

REF 10.237

NAZARE S	QTY	N.W	G.W	C.B.M	SIZE
Packing	1	40.1kg	43.3kg	0.32	730x430x1010mm

* 10.236 Graphic Size: 670x2300mm x2
750x2300mm x5

NAZARE C	QTY	N.W	G.W	C.B.M	SIZE
Packing	1	40.1kg	43.3kg	0.32	730x430x1010mm

* 10.237 Graphic Size: 670x2300mm x2
700x2300mm x5

EN 2 Hard cases with wheels included.
FR 2 valise rigide avec roulette incluse.

PT Inclui 2 malas rígidas com rodas.
ES Incluye 2 maletas rígidas con ruedas.

TEIDE 8x3 "S"



Biggest Pop-Up



double sided
with 4 spotlights,
2 trolleys/counters
and 1 magnetic strip roll

INFORMATION

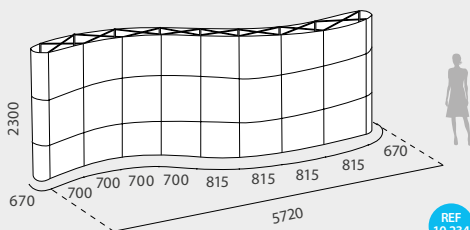

*mm



REF 10.234

- Includes 4 Spotlights for accenting your graphics.
- The 2 trolley hard-cases with wheels can be used as counters.
- Wrap for the cases can be customized with printed graphics.
- With 1 roll of magnetic strip for attachment of the graphics.
- Featuring double sided wall, ideal for creating spaces as divider at tradeshows, promotional booths or specials shows at any media event.
- The magnetic Pop Up is ideal for enhancing your business's presence at your next media event, exhibition, tradeshow, convention or exposition. The "pop up displays", also known as exhibition booths feature a straight or curved brushed aluminum frame that is lightweight, yet sturdy. Custom graphics are attached to the frame with magnetic loop strips (yet with adhesive to the magnetic strip). The entire portable display can be set up and taken down in only a few minutes.

Double Sided

TEIDE S	QTY	NW	G.W	C.B.M	SIZE
Packing	2	35.6kg 30kg	36.6kg 31kg	0.32 0.32	730x430x1010mm 730x430x1010mm
10.234		Graphic Size:		670x2300mm x2 700x2300mm x8 815x2300mm x8	 

ESCALONA SOFT-CASE TROLLEY

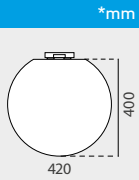

INFORMATION

Made of Nylon with closures and zippers, 2 handle straps, 1 extendable handle and wheels. Escalona is ideal for protecting and transporting Pop Ups.

ESCALONA	QTY	N.W	G.W	C.B.M	SIZE
Packing	1	15kg	18.6kg	0.12	680x170x1030mm
	10.060	Trolley Size: 420x420x790mm			

NOVES HARD-CASE TROLLEY

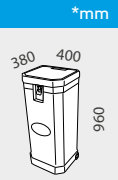

INFORMATION

Made of hard PVC, design lasts through long-term uses. Includes high-quality clasps and rubber wheels. Ideal for being labelled and used as counter.

NOVES	QTY	N.W	G.W	C.B.M	SIZE
Packing	1	7kg	9.1kg	0.18	410x430x1000mm
	10.059	Graphic size for Counter: 1450x745mm			

MAQUEDA TROLLEY HARD-CASE

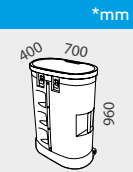

INFORMATION

Made of hard PVC, design lasts through long-term uses. Includes high-quality clasps, rubber wheels and handles. Ideal for carrying case makes easy to transport your trade show accessories and exhibits in between events.

MAQUEDA	QTY	N.W	G.W	C.B.M	SIZE
Packing	1	13kg	15.2kg	0.32	710x420x1010mm
	10.058	Trolley: 700x400x960mm Graphic: 1810x795mm			

TABLE TOP FOR POP UP



INFORMATION

Includes nylon carry bag with ID Pocket and handles. Black or Silver color available. Foldable for transportation. Ideal to consolidate your trolley as a promotional counter, providing more surface to display in your event presentation.

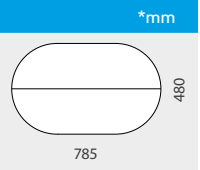

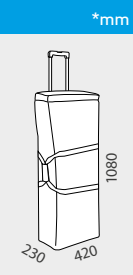



TABLE TOP	QTY	N.W	G.W	C.B.M	SIZE
Uni.	1	4.2kg	5.0kg	0.05	830x270x220mm
	10.309	785x480x16mm			
	10.310				

TROLLEY SOFT-CASE



INFORMATION

Trolley made of black nylon with closures and zippers, 2 handle straps, 1 extendable handle and wheels.

TROLLEY S.C.1	QTY	N.W	G.W	C.B.M	SIZE
Packing	1	3.75kg	5.7kg	0.13	455x265x1160mm
	13.456	420x230x1080mm			

TROLLEY SOFT-CASE

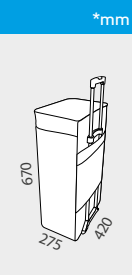

INFORMATION

Trolley made of black nylon with closures and zippers, 2 handle straps, 1 extendable handle and wheels.

TROLLEY S.C.2	QTY	N.W	G.W	C.B.M	SIZE
Packing	1	4.15kg	5.5kg	0.12	440x340x820mm
	13.457	420x275x670mm			

* Counter is not included / Présentoir non inclus / Balcão não incluídos / Mostrador no incluido.

* Counter is not included / Présentoir non inclus / Balcão não incluídos / Mostrador no incluido.

POP UP ACCESSORIES | Spotlights | Spotlight Bag



- EN** Spotlights for Pop Up promotional support. With double clamp base. Works directly plugged in. Black or silver finishing.
- FR** Foyer d'éclairage pour supports Pop Up. Se branche directement sur le secteur. Finition en noir ou argent.
- PT** Focos de iluminação para Pop Up com pinça. Inclui cabo com ficha para ligação à tomada e lâmpada.
- ES** Focos de iluminación, ideal para Pop Up. Con soporte de doble pinza. Funciona a corriente. Acabado en negro o plata.

SPOTLIGHT FOR POP UP



INFORMATION

*mm

- Double clamp base.
- 150w light included.
- Ideal for illuminating your exhibit booth and shed light on your displayed products and promotional services.

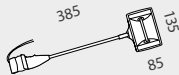

SPOTLIGHT	QTY	N.W	G.W	C.B.M	SIZE	
Packing	1	0.65kg	0.7kg	0.0038	150x50x510mm	 
 10.368					150 w	

LED SPOTLIGHT FOR POP UP

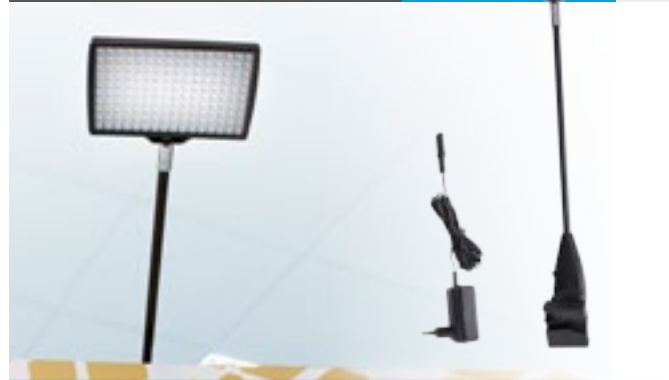

INFORMATION

*mm

- Double clamp base.
- 12W LED light included.
- Ideal for illuminating your exhibit booth and shed light on your displayed products and promotional services.

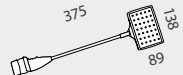

LED SPOTLIGHT	QTY	N.W	G.W	C.B.M	SIZE	
Packing	1	0.45kg	0.85kg	0.0038	150x50x510mm	  
 10.688					12 W	

ECONOMIC LED SPOTLIGHT FOR POP UP



ECONOMIC







NEW

INFORMATION

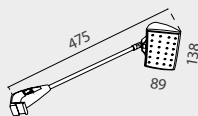
*mm

- Clamp base.
- 10W LED light included.
- Ideal for illuminating your exhibit booth and shed light on your displayed products and promotions.



ECONOMIC L.S.	QTY	N.W	G.W	C.B.M	SIZE	
Packing	30	0.3kg	11kg	0.1028	605x515x330mm	  
 13.753					10 W	18V

OXFORD BAG FOR POP UP SPOTLIGHTS



easy transport by handle



INFORMATION

*mm

- Made of black nylon and all crossed zipped.
- The Oxford Bag protects and extends the life of your Pop Up Spotlights. Easy transport by handles.

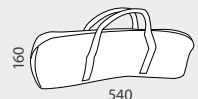

OXFORD BAG	QTY	N.W	G.W	C.B.M	SIZE	
Packing	1	0.15kg	0.20kg	0.002	160x30x540mm	
 13.455						

* Spotlights not included / Spotlights non inclus / Focos não incluídos / Focos no incluídos.

TOP AND BOTTOM BAR GRAPHIC (3x3)

- EN Top and bottom bars pack for Pop Up 3x3.
- FR Kit de bandes de suspension pour Pop Up 3x3.
- PT Kit de tiras de suspensão para Pop Up 3x3.
- ES Pack de Perchas/Zócalos para Pop Up 3x3.



TOP AND BOTTOM BAR GRAPHIC (4x3)

- EN Top and bottom bars pack for Pop Up 4x3.
- FR Kit de bandes de suspension pour Pop Up 4x3.
- PT Kit de tiras de suspensão para Pop Up 4x3.
- ES Pack de Perchas/Zócalos para Pop Up 4x3.

INFORMATION 3x3 Pop Ups

- Available Pack of 10 bars for **Straight 3x3 Pop Up** (5 Bottom and 5 Top).
- Available Pack of 6 bars for **Back curved 3x3 Pop Up** (3 Bottom and 3 Top).
- Available Pack of 10 bars for **Front curved 3x3 Pop Up** (5 Bottom and 5 Top).

STRAIGHT BAR	QTY	N.W	G.W	C.B.M	SIZE
Packing	10	0.68kg	0.7kg	0.0008	55x20x750mm
 10.714	Straight 3x3		Pack: 5 Bottom + 5 Top		

C.FRONT BAR	QTY	N.W	G.W	C.B.M	SIZE
Packing	10	0.7kg	0.72kg	0.0007	55x20x700mm
 10.715	Curved/Front 3x3		Pack: 5 Bottom + 5 Top		

C.BACK BAR	QTY	N.W	G.W	C.B.M	SIZE
Packing	6	0.46kg	0.48kg	0.0004	55x10x810mm
 10.491	Curved/Back 3x3		Pack: 3 Bottom + 3 Top		

INFORMATION 4x3 Pop Ups

- Available Pack of 12 bars for **Straight 4x3 Pop Up** (6 Bottom and 6 Top).
- Available Pack of 8 bars for **Back curved 4x3 Pop Up** (4 Bottom and 4 Top).
- Available Pack of 12 bars for **Front curved 4x3 Pop Up** (6 Bottom and 6 Top).

STRAIGHT BAR	QTY	N.W	G.W	C.B.M	SIZE
Packing	12	0.83kg	0.85kg	0.0008	55x20x750mm
 10.716	Straight 4x3		Pack: 6 Bottom + 6 Top		

C.FRONT BAR	QTY	N.W	G.W	C.B.M	SIZE
Packing	12	0.78kg	0.8kg	0.0007	55x20x700mm
 10.717	Curved/Front 4x3		Pack: 6 Bottom + 6 Top		

C.BACK BAR	QTY	N.W	G.W	C.B.M	SIZE
Packing	8	0.6kg	0.62kg	0.0004	55x15x810mm
 10.492	Curved/Back 4x3		Pack: 4 Bottom + 4 Top		

MAGNETIC BAR

- EN Magnetic bar. Suitable for models: Madrigal, Gredos, Arévalo, Laredo and Llanes.
- FR Barre magnétique. Compatible avec: Madrigal, Gredos, Arevalo, Laredo et Llanes.
- PT Barra magnética compatível com: Madrigal, Gredos, Arevalo, Laredo, LLanes.
- ES Barra magnética. Válida en modelos: Madrigal, Gredos, Arévalo, Laredo y Llanes.



720mm bar for Pop Up

INFORMATION

- See model of Pop Up for compatibility.
- With rail to insert the adhesive magnetic strip.
- Bars for construction of magnetic structures for Pop Ups.

MAGNETIC BAR	QTY	N.W	G.W	C.B.M	SIZE
Packing	1	0.2kg	0.22kg	0.0003	50x10x760mm
 10.419	720mm				

MAGNETIC STRIP ROLL 12mm

- EN Magnetic strip roll, 50 metres length for fixing Pop Up graphics.
- FR Rouleau magnétique de 50m pour la fixation des images au Pop Up.
- PT Rolo magnético com 50 metros para fixar impressões de Pop Up.
- ES Rollo de imán de 50 metros para la fijación de gráficas de Pop Up.



INFORMATION

- 50m Roll.
- 2mm thickness strip.
- One adhesive side for fixing to the graphics.

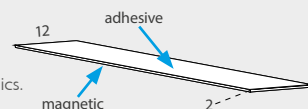

M.STRIP ROLL	QTY	N.W	G.W	C.B.M	SIZE
Packing	1	3.4kg	3.82kg	0.0038	390x25x390mm
 10.360	50m x 12mm				

EN PVC pannel for Pop Up.
FR Panneau en PVC pour Pop Up.

PT Painel de PVC para Pop Up.
ES Panel de PVC para Pop Up.

INFORMATION *mm

- Made of 0.4mm white PVC.
- Ideal for printing graphics for Pop Up.

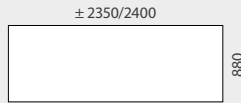

PVC PANNEL	QTY	N.W	G.W	C.B.M	SIZE
Packing	1	1.15kg	2.5kg	0.015	130x130x890mm
	10.101	±2350/2400x880x0.4mm			

PVC PANNEL FOR POP UPS



high-quality white 0.4mm PVC

CONNECTING PIECES FOR POP UPS



PLASTIC PIECE FOR MAGNETIC BAR

PLASTIC PIECE FOR POP UP CORNER

PLASTIC PIECE FOR BAR GRAPHICS *mm

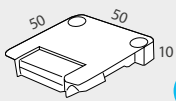

REF 10.858

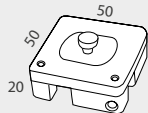
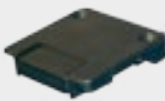

REF 10.409

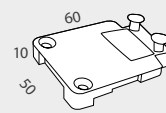

REF 10.859



PIECE M.	QTY	N.W	G.W	C.B.M	SIZE
Packing	1	0.014kg	0.015kg	0.00002	50x10x50mm
	10.858	50x50x10mm			

CORNER	QTY	N.W	G.W	C.B.M	SIZE
Packing	1	0.038kg	0.039kg	0.00007	50x30x50mm
	10.409	50x50x20mm			

PIECE B.	QTY	N.W	G.W	C.B.M	SIZE
Packing	1	0.02kg	0.021kg	0.00006	55x20x60mm
	10.859	60x50x10mm			

CROSS FOR FABRIC POP UPS



INFORMATION

- One unit cross of replacement for structures on Pop Ups with magic tape system.

CROSS F.P.U.	QTY	N.W	G.W	C.B.M	SIZE
Packing	1	0.70kg	0.80kg	0.005	80x80x800mm
	96.117				

HORIZONTAL CROSS FOR MAGNETIC POP UPS



INFORMATION

- One unit cross of replacement for structures on Pop Ups with magnetic system.

HORIZONTAL C.	QTY	N.W	G.W	C.B.M	SIZE
Packing	1	0.70kg	0.80kg	0.005	80x80x800mm
	10.897				

EN

Special profile system made of aluminium for textil. Profiles sizes are available in standard or linear meters. The textil should be sewn to a silicone "strip" around all its perimeter, then it is inserted into the rail of the profile being tight and perfectly framed.

FR

Profil spécial en aluminium pour textile. Les profils sont fournis en formats standard ou en barre. Facile et rapide à assembler. Le textile se coud sur une « bande de silicone », qui va s'introduire dans la rainure du profil ce qui permet un visuel parfaitement présenté, tendu et encadré.

PT

Perfil em alumínio para impressão em têxtil. Os perfis são fornecidos em medidas estandardizadas ou por metro linear. O tecido deve ser cosido a uma tira de silicone, que posteriormente será introduzida na ranhura do perfil de modo a ficar tenso e perfeitamente colocado.

ES

Sistema de perfileria de aluminio para tejidos. Los perfiles se suministran en medidas estándar o por metros lineales. El tejido es cosido a una "tira" de silicona en todo su perímetro, posteriormente para su fijación y tensado se introduce en el rail de la perfileria quedando perfectamente enmarcada.



INFORMATION

- The TextFix Profile System is ideal for dressing and setting up shops, for showrooms, offices promotional booths, windows dressing or fair stands. Whether you want a wall frame, a backlite divider, a light totem, a standalone or hanging frame, you will find the right solution with our wide range of TextFix system.

- Among all TextFix options available to choose your most suitable profile are: Thin profiles, simple and double sided profiles, standard measurements or by linear meters, complete kit with lighting, blackened aluminum profiles, profiling designed for large surfaces and a complete series of accessories: hangers, bases, trays, connectors, etc...

APPLICATIONS | TEXTIFIX



TEXTIL ARTWORK *mm

INSTALL EXPLANATION | TEXTIFIX

- Place the hangers and fix them.
- Locate the corners connectors and join the aluminium profiles.
- Screw the corners and insert the silicone of the textil into the rail of the profile, get it total framed.

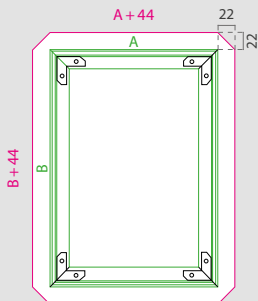

PROFILE SIZE TEXTIL TOTAL SIZE



TEXTFIX LIGHT
ULTRA SLIM FRAME 15.5mm

- EN Single aluminum frame profile with LEDs. Easy and quick to assemble.
- FR Profil, simple face, lumineux en aluminium. Facile à assembler.
- PT Perfil simples para moldura com LEDs. De fácil e rápida montagem. Alumínio.
- ES Perfil simple de aluminio con sistema de LEDs. Montaje fácil y rápido.



15.5 mm
thickness



INFORMATION

*mm

- Featuring single-sided slim design of 15.5mm thickness.
- With LED system included. (lower power consumption)
- It's ideal for wall mounting at showrooms, expositions or windows/shop dressing.
- Other sizes of this profile are available upon a request.

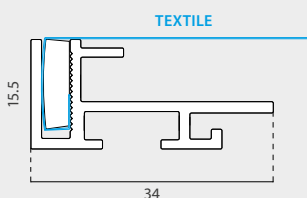

*Printed on fabric.
Impression sur toile.
Impressão em tecido.
Impresión en tela.

* Other sizes available upon request / Disponible autres des tailles par demande
Otras medidas mediante consulta / Otras medidas disponibles bajo consulta.

STANDARD SIZES

TF ULTRA SLIM	GRAPHIC SIZE
13.180	A4
13.179	A3
13.178	A2
13.177	A1
13.176	A0
13.306	500x700mm
13.307	700x1000mm



- see Graphic Cases at
Roll Up accessories -

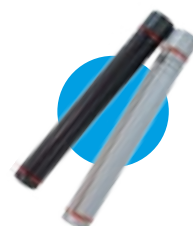

EN Includes: 4 simple profiles, 4 corners and 1 Allen key type. Optional hangers available.

FR inclus: 4 profils simples, 4 équerres et 1 clef Allen. Crochets vendus séparément.

PT Inclui 4 perfis simples, 4 esquinas e 1 chave tipo Allen. Suspensão opcional.

ES Incluye 4 perfiles simples, 4 esquineros y 1 llave tipo Allen. Colgadores opcionales.

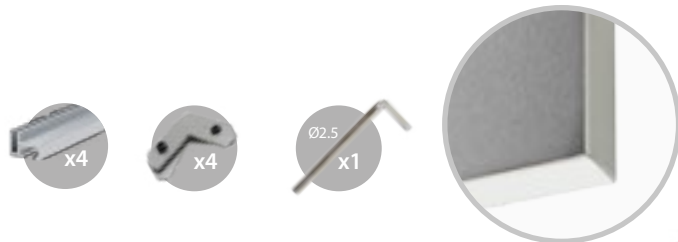

TEXTIFIX FRAME 16mm



INFORMATION

*mm

- Set includes: 4 simple aluminum profiles, 4 corners and 1 Allen key.
- It's perfectly suitable for dressing and setting up shops, showrooms, offices and fair stands.
- Also displaying it as a promotional picture using hangers available next in TextFix accessories.

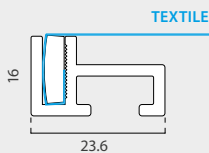

STANDARD SIZES

TEXTIFIX 16	GRAPHIC SIZE	
✿ 13.132	A4	🌀
✿ 13.133	A3	🌀
✿ 13.134	A2	🌀
✿ 13.135	A1	🌀 T
✿ 13.136	500x700mm	🌀 T
✿ 13.137	700x1000mm	🌀 T
✿ 13.138	500x1000mm	🌀 T



- optional hangers at TextFix accessories -



*Printed on fabric. Impression sur toile. Impresão em tecido. Impresión en tela.

- T
- EN** Fixing on the wall with screws in these sizes.
 - FR** Fixer avec des vises pour toutes les tailles.
 - PT** Fixar à parede seguindo as medidas indicadas.
 - ES** Fijar con tornillos a la pared en estas medidas.

ALUMINIUM PROFILE BY LINEAR METERS

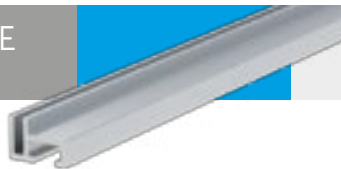

EN Includes 4 units of 3m. Total 12m.

FR Inclus 4 barres de 3 m. Total 12m.

PT Inclui 4 perfis de 3m. Total: 12m.

ES Incluye 4 perfiles de 3m. Total 12m.

PROFILE

*mm

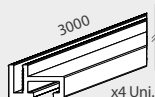

T.Fix16 | m SIZE

✿ 13.139 4 Uni. x 3m/=12m/l 🌀

CORNER CONNECTORS



CONNECTOR

*mm

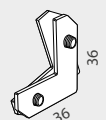

CORNER 16mm

✿ 13.171 x20 🌀

- EN Simple aluminum frame profile for textile digital printing. Special for free spaces on walls. Easy and quick to assemble.
- FR Profil simple en aluminium pour des impressions digitales en textile et de montage facile. Idéal pour combler des espaces vides.
- PT Perfil simples de alumínio que permitem a colocação de impressões têxteis digitais. De fácil montagem. Ideal para cavidades nas paredes.
- ES Perfil simple de aluminio para colocación en huecos y espacios libres en muros. Montaje fácil y rápido. Impresión sobre textil.

TEXTIFIX WALL FRAME 27.5mm

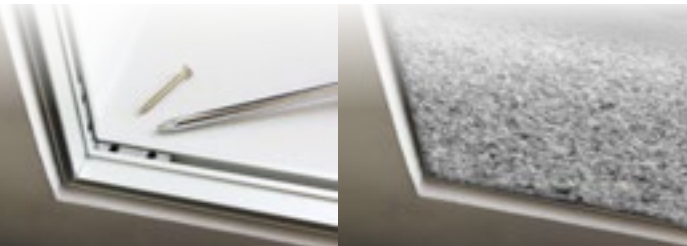

INFORMATION

*mm

- This set includes: 4 Double-sided profiles, 4 corners and 1 Allen key.
- Thanks to its 27.5mm width profile is ideal for creating promotional frames at free spaces on the walls, dressing and setting up shops, fair stands, showrooms or offices.

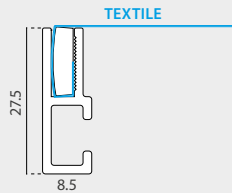

simple set-up



*Printed on fabric.
Impression sur toile.
Impressão em tecido.
Impresión en tela.



ALUMINIUM PROFILE BY LINEAR METERS



- EN Includes 4 units of 3m. Total 12m.
- FR Inclus 4 barres de 3 m. Total 12m.
- PT Inclui 4 perfis de 3m. Total: 12m.
- ES Incluye 4 perfiles de 3m. Total 12m.

PROFILE *mm

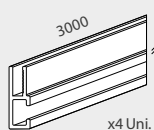

CORNER CONNECTORS



CONNECTOR *mm

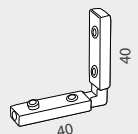

T.FIX27.5 | m

SIZE

13.157



4 Uni. x 3m/1=12m/1

CORNER 40x40

13.243

x20 

TEXTFIX FRAME
DOUBLE-SIDED 41.5x16mm

EN	Double-sided frame profile. Includes: 4 simple profiles, 4 corners and 1 Allen key type. Optional hangers available.	PT	Perfil dupla face em alumínio. Inclui 4 perfis simples, 4 esquinas e 1 chave tipo Allen (suspensão opcional).
FR	Profil double en aluminium inclus: 4 profils simples, 4 équerres et 1 clef Allen. Crochets vendus séparément.	ES	Perfil doble para elaboración de marcos. Incluye 4 perfiles, 4 esquineros y 1 llave tipo Allen. Colgadores opcionales.



double sided



INFORMATION *mm

- Set includes:
4 simple aluminum profiles.
4 corners and 1 Allen key.
- Thanks to its double-sided profile it is perfectly suitable for dressing and setting up shops, showrooms, offices and fair stands.

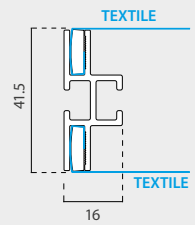

STANDARD SIZES

T.FI 41.5x16	GRAPHIC SIZE
13.158	A4
13.159	A3
13.160	A2
13.161	A1

 *Printed on fabric. Impression sur toile. Impresão em tecido. Impresión en tela.

ALUMINIUM PROFILE BY LINEAR METERS

EN	Includes 4 units of 3m. Total 12m.
FR	Inclus 4 barres de 3 m. Total 12m.
PT	Inclui 4 perfis de 3m. Total: 12m.
ES	Incluye 4 perfiles de 3m. Total 12m.

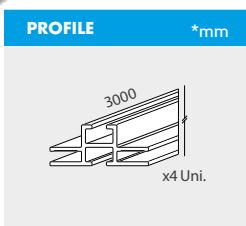

41.5x16mm	QTY	N.W	G.W	C.B.M	SIZE
Packing	4	4.66kg	5.11kg	0.0147	75x65x3015mm
13.170					4 Uni. x 3m/l=12m/l

CORNER CONNECTORS



CORNER 40x40	13.243	x20
--------------	--------	-----

TEXTIFIX FRAME
DOUBLE-SIDED 41.3x38.1mm

- EN Double-sided aluminum frame profile for textile digital printing. Includes: 4 Profiles, 4 corners and 1 Allen key type. Bases not included.
- FR Profil double en aluminium pour des impressions digitales en textile. . 4 profils, 4 équerres et 1 clef Allen inclus. Socles non inclus.
- PT Perfil dupla face em alumínio para colocação de impressões têxteis. Inclui 4 perfis, 4 esquinas e 1 chave tipo Allen. Pés não incluídos.
- ES Perfil doble para la elaboración de marcos de aluminio. El set incluye: 4 perfiles, 4 esquineros y 1 llave tipo Allen. Las bases no están incluidas.

double sided

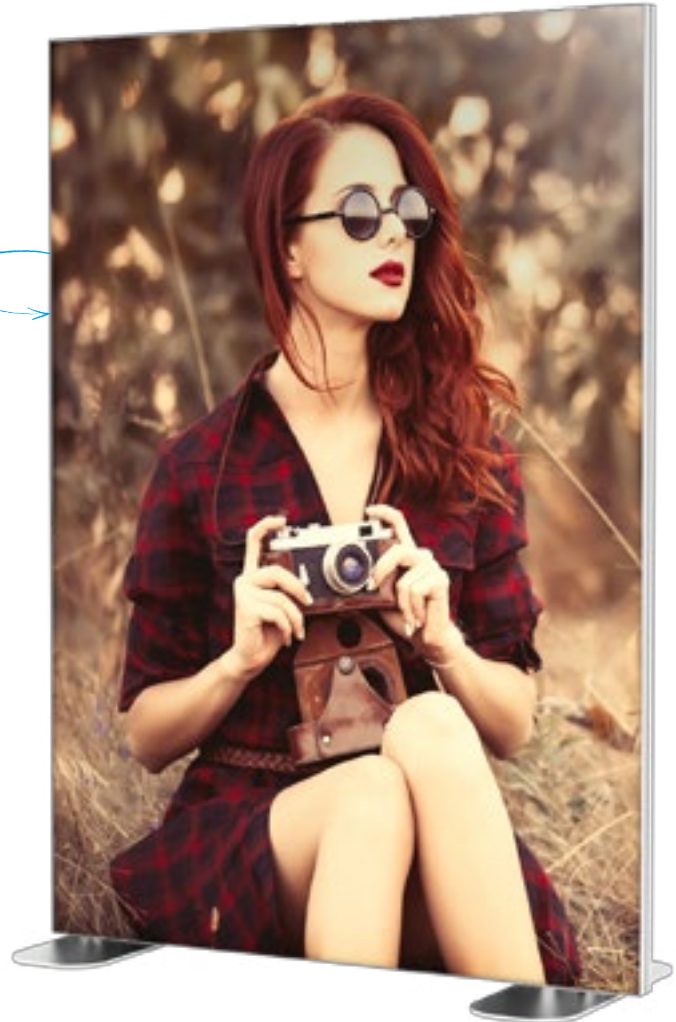

INFORMATION

*mm

- This set includes: 4 Double-sided profiles, 4 corners and 1 Allen key.
- It's perfectly suitable for dressing and setting up shops, showrooms, offices and fair stands, displaying it as a totem using feet bases available next in TextFix accessories.

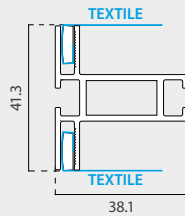

STANDARD SIZES

TF 41.3x38.1	GRAPHIC SIZE
13.163	500x700mm
13.166	500x1000mm
13.164	700x1000mm
13.162	A0
13.167	1000x1000mm
13.165	1000x1400mm
13.168	1000x1500mm
13.282	700x2000mm
13.169	1000x2000mm



 *Printed on fabric. Impression sur toile. Impressão em tecido. Impresión en tela.

ALUMINIUM PROFILE BY LINEAR METERS

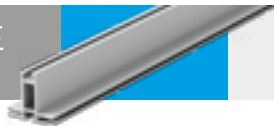

- EN Includes 4 units with 3m. Total 12m.
- FR Inclus 4 barres de 3 m. Total 12m.
- PT Inclui 4 perfis de 3m. Total: 12m.
- ES Incluye 4 perfiles de 3m. Total 12m.

PROFILE *mm

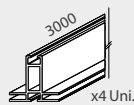

CORNER CONNECTORS



CONNECTOR *mm

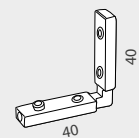

TF 41.3x38.1mm

SIZE

13.058

 4 Uni. x 3m/l=12m/l

CORNER 40x40

13.243

x20 

ALUPROFIT
TEXTIFIX FRAME 49mm



- EN Double-sided aluminum frame profile for textile printing. Black or aluminium finish. Includes: 2 Profiles, 4 corners and 1 Allen key type. Bases not included.
- FR Profil double en aluminium pour des impressions en textile. Disponible en gris ou en noir. 2 profils, 4 équerres et 1 clef Allen inclus. Socles non inclus.
- PT Perfil dupla face em alumínio para impressões têxteis. Disponível em preto ou cinzento. Inclui 2 perfis, 4 esquinas e 1 chave tipo Allen. Pés não incluídos.
- ES Perfil doble para la elaboración de marcos de aluminio. Acabado en negro o aluminio. Incluye: 2 perfiles, 4 esquineros y 1 llave Allen. Bases no incluidas.



 *Printed on fabric.
Impression sur toile.
Impressão em tecido.
Impresión en tela.

double sided



INFORMATION

*mm

This TexFix frame features silver or black color and it is available in 3 sizes (2000, 3000 and 4000mm length). Also, each pack comes with 2 units. Aluprofit TexFix is an aluminium profile very used for dressing and setting up shops, showrooms, offices and fair stands or for using as a backlite totem display thanks its double sided option.

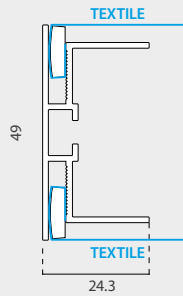

ALUMINIUM PROFILE SIZES

ALUPROFIT		SIZE
13.644	 	 2 Uni. x 2000mm
13.645	 	 2 Uni. x 3000mm
13.646	 	 2 Uni. x 4000mm

simple set-up

CORNER 40x40

13.243  x20

CORNER CONNECTORS

CONNECTOR *mm

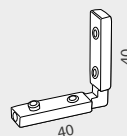

TEXTIFIX WALL FRAME
81.5mm

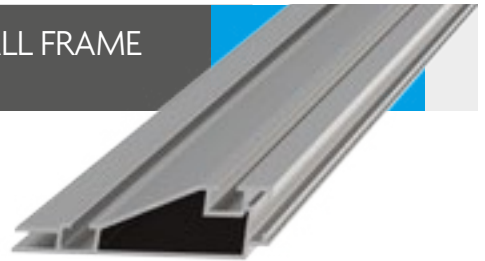

EN Includes: 4 simple profiles, 4 corners and 1 Allen key type. Optional hangers available.
FR inclus: 4 profils simples, 4 équerres et 1 clef Allen. Crochets vendus séparément.

PT Inclui 4 perfis simples, 4 esquinas e 1 chave tipo Allen. Suspensão opcional.
ES Incluye 4 perfiles simples, 4 esquineros y 1 llave tipo Allen. Colgadores opcionales.



simple set-up

INFORMATION *mm

This TextFix frame features silver or black color and it is available in 3 sizes (2000, 3000 and 4000mm length). Also, each pack comes with 2 units. Aluprofit TextFix is an aluminium profile very used for dressing and setting up shops, showrooms, offices and fair stands or for using as a backlite totem display.

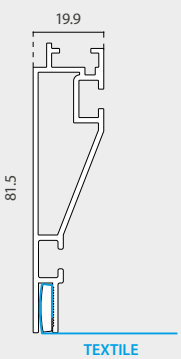

ALUMINIUM PROFILE SIZES

WALL F. 81.5	SIZE	
13.647	 2 Uni. x 2000mm	
13.648	 2 Uni. x 3000mm	
13.649	 2 Uni. x 4000mm	



*Printed on fabric.
Impression sur toile.
Impressão em tecido.
Impresión en tela.

CORNER CONNECTORS



CONNECTOR *mm

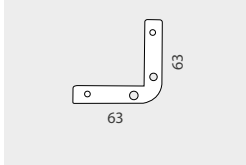

CORNER

13.333 x20 

CORNER CONNECTORS



CONNECTOR *mm

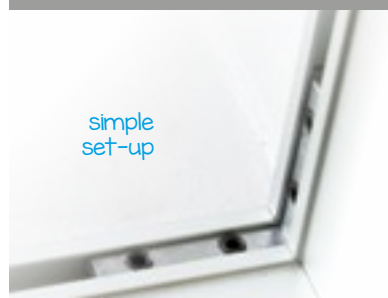
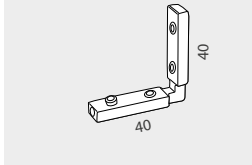

CORNER 40x40

13.243 x20 

TEXTIFIX | 100mm Double-Sided Frame Profile

TEXTIFIX FRAME DOUBLE-SIDED 100x20.5mm

EN Double-sided aluminum frame profile for textile printing. Black or aluminium finish. Includes: 4 Profiles, 4 corners and 1 Allen key type. Bases not included.

FR Profil double en aluminium pour des impressions en textile. Disponible en gris ou en noir. 4 profils, 4 équerres et 1 clef Allen inclus. Socles non inclus.

PT Perfil dupla face em alumínio para impressões têxteis. Disponível em preto ou cinzento. Inclui 4 perfis, 4 esquinas e 1 chave tipo Allen. Pés não incluídos.

ES Perfil doble para la elaboración de marcos de aluminio. Acabado en negro o aluminio. Incluye: 4 perfiles, 4 esquineros y 1 llave Allen. Bases no incluidas.

INFORMATION

*mm

- This set includes: 4 Double-sided profiles, 4 corners and 1 Allen key.
- It's perfectly suitable for dressing and setting up shops, showrooms, offices and fair stands, displaying it as a totem using feet bases available next in TexFix accessories.

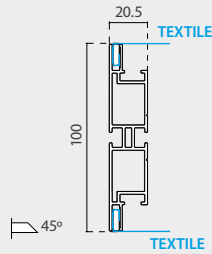

* The ends are mitred / Couper en biais à 45° / Corte em esquadria de 45° / Cortado a inglete.

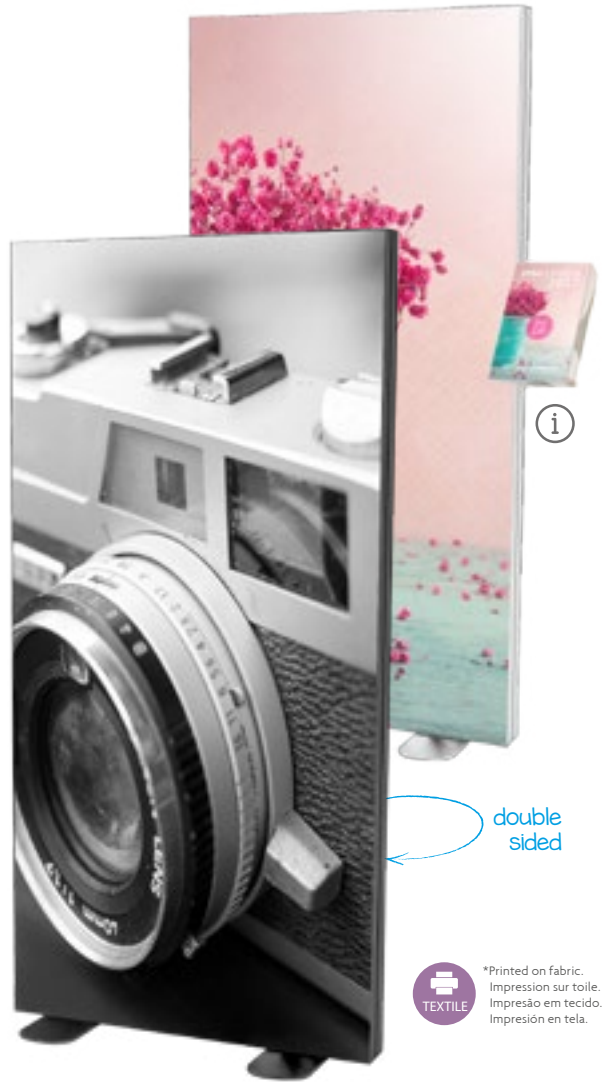

double sided

 *Printed on fabric.
Impression sur toile.
Impressão em tecido.
Impresión en tela.



 - optional tray at TexFix accessories -

ALUMINIUM PROFILE SIZES

100x20.5	SIZE		100x20.5	SIZE	
 13.300	500mm	x2 	 13.303	2000mm	x2 
 13.301	1000mm	x2 	 13.304	2500mm	x2 
 13.302	1500mm	x2 	 13.305	3000mm	x2 

CENTRAL CONNECTOR PROFILE



CONNECTOR *mm

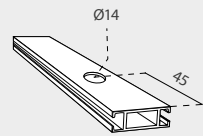

STANDARD SIZES

CENTRAL		SIZE		
13.342		600mm	x2	
13.343		700mm	x2	
13.344		1000mm	x2	
13.345		1500mm	x2	
13.346		2000mm	x2	
13.347		2500mm	x2	
13.348		3000mm	x2	

LINEAR METERS

CENTRAL	QTY	N.W	G.W	C.B.M	SIZE
Packing	4	5.05kg	5.40kg	0.0147	75x65x3020mm
	13.246			4 Uni. x 3m/l=12m/l	

CORNER CONNECTORS



CORNER	QTY	N.W	G.W	C.B.M	SIZE
Packing	20	0.66kg	0.85kg	0.0005	75x75x90mm
	13.333			x20	

LOCK



LOCK *mm

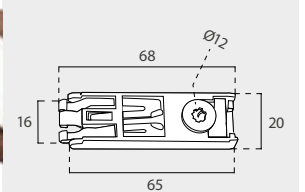

LOCK

SIZE

13.244

x2



TEXTFIX COMPLETE KITS
DOUBLE-SIDED WITH LIGHT
FRAME 100x20.5mm

EN	Double Aluminum Profile for light frame using digital printing textile. Black or aluminium finish. Prices for complete kit.
FR	Profil lumineux double face en aluminium pour des impressions sur textile. Disponible en gris ou en noir. Prix par kit complet.
PT	Perfil duplo de alumínio com luz para impressões digitais em têxtil. Disponível em preto ou cinzento. Preço para kit completo.
ES	Perfil doble de aluminio con luz para impresiones digitales sobre textil. Acabado en negro o aluminio. Precio por kit completo.

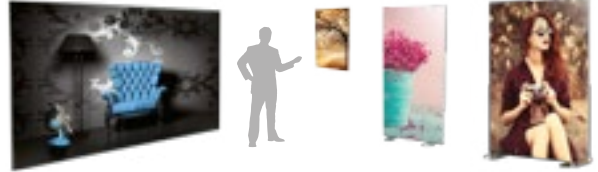

superb illumination 



double sided

low energy consumption



*Printed on fabric.
Impression sur toile.
Impressão em tecido.
Impresión en tela.



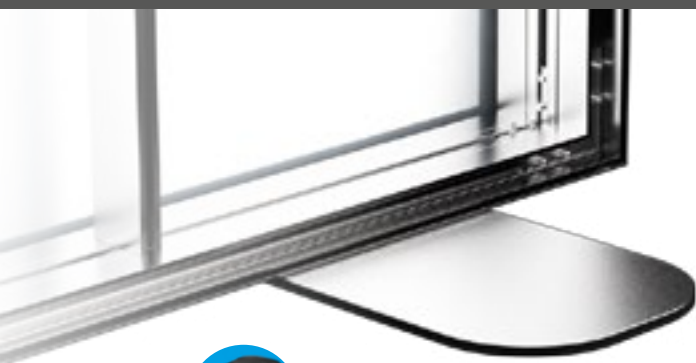

- optional bases at TexFix accessories -

13.175

INFORMATION

*mm

- This set includes: 4 Double-sided profiles, 4 corners and 1 Allen key.
- It's perfectly suitable for dressing and setting up shops, showrooms, offices and fair stands, displaying it as a totem using feet bases available next in TexFix accessories.

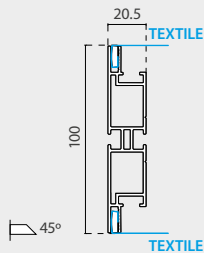

* The ends are mitred / Couper en biais à 45° / Corte em esquadria de 45° / Cortado a inglete.

TEXFIX COMPLETE KITS DOUBLE-SIDED WITH LIGHT FRAME 100x20.5mm



COMPLETE KIT INCLUDES



1 PROFILES & CORNER CONNECTIONS



x2 silver or x2 black profile

2 LED LIGHT SYSTEM



3 CENTRAL CONNECTOR PROFILE & LOCK*



CONNECTOR

*mm

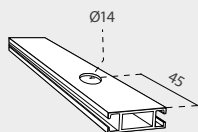

* Only included in required measures / Seulement inclus pour les dimensions requis / Incluído somente nas medidas mencionadas / Incluído sólo en medidas requeridas.











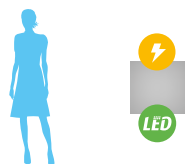





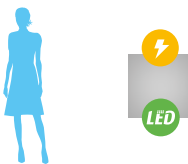

4 ACCESSORIES





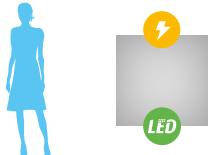
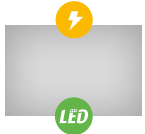

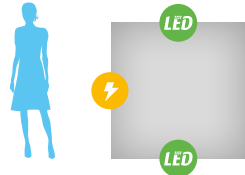

INFORMATION

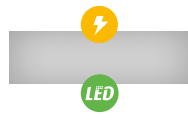
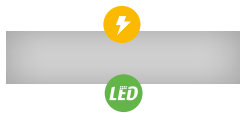
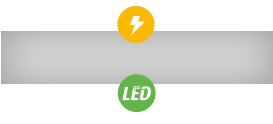
- Zinc screws.
- Cable with plug.
- 2.5mm Allen wrench.
- Electric clamp for cable.
- Easy grommet placement.
- Cable for internal connection.
- 4mm Allen wrench for locks*.

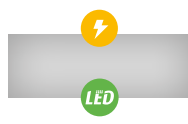
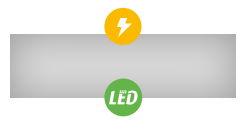
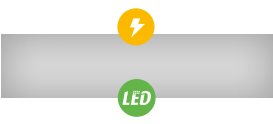

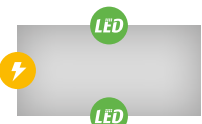
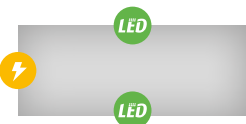
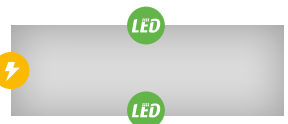
* Only included in required measures / Seulement inclus pour les dimensions requis / Incluído somente nas medidas mencionadas / Incluído sólo en medidas requeridas.

	600mm	700mm	1000mm	1500mm
600mm				
	LED 500 x1 Uni.	LED 500 x1 Uni. Use in 600mm side	LED 500 x1 Uni. Use in 600mm side	LED 500 x2 Uni. Use in 600mm sides
	Pw. 60W/24V x1 Uni.	Pw. 60W/24V x1 Uni.	Pw. 60W/24V x1 Uni.	Pw. 60W/24V x1 Uni.
	*13.308 	*13.309 	*13.310 	*13.311 
700mm				
		LED 500 x1 Uni.	LED 500 x1 Uni. (In 700mm side)	LED 500 x2 Uni. (In 700mm sides)
		Pw. 60W/24V x1 Uni.	Pw. 60W/24V x1 Uni.	Pw. 60W/24V x1 Uni.
		*13.315 	*13.316 	*13.317 
1000mm				
			LED 500 x1 Uni. LED 300 x1 Uni.	LED 500 x2 Uni. LED 300 x1 Uni.
			Pw. 60W/24V x1 Uni. (In 1000mm sides)	Pw. 60W/24V x1 Uni. (In 1500mm sides)
			*13.321 	*13.322 
1500mm				
				LED 500 x4 Uni. LED 300 x2 Uni.
				Pw. 100W/24V x1 Uni. (In 1500mm sides)
				*13.326 

2000mm		2500mm		3000mm		
						600mm
LED 300 x1 Uni. + LED 500 x3 Uni. (In 2000mm sides)		LED 500 x3 Uni. LED 300 x2 Uni. (In 2500mm sides)		LED 500 x4 Uni. LED 300 x2 Uni. (In 3000mm sides)		
Pw. 100W/24V x1 Uni.	1 x Transverse Reinforc.	Pw. 100W/24V x1 Uni.	1 x Transverse Reinforc.	Pw. 100W/24V x1 Uni.	2 x Transverse Reinforc.	
* 13.312	<input type="checkbox"/>	* 13.313	<input type="checkbox"/>	* 13.314	<input type="checkbox"/>	
						700mm
LED 300 x1 Uni. + LED 500 x3 Uni. (In 2000mm sides)		LED 500 x3 Uni. LED 300 x2 Uni. (In 2500mm sides)		LED 500 x4 Uni. LED 300 x2 Uni. (In 3000mm sides)		
Pw. 100W/24V x1 Uni.	1 x Transverse Reinforc.	Pw. 100W/24V x1 Uni.	1 x Transverse Reinforc.	Pw. 100W/24V x1 Uni.	2 x Transverse Reinforc.	
* 13.318	<input type="checkbox"/>	* 13.319	<input type="checkbox"/>	* 13.320	<input type="checkbox"/>	
						1000mm
LED 500 x6 Uni. + LED 300 x2 Uni. (In 2000mm sides)		LED 500 x6 Uni. LED 300 x4 Uni. (In 2500mm sides)		LED 500 x8 Uni. LED 300 x4 Uni. (In 3000mm sides)		
Pw. 150W/24V x1 Uni.	1 x Transverse Reinforc.	Pw. 150W/24V x1 Uni.	1 x Transverse Reinforc.	Pw. 200W/24V x1 Uni.	2 x Transverse Reinforc.	
* 13.323	<input type="checkbox"/>	* 13.324	<input type="checkbox"/>	* 13.325	<input type="checkbox"/>	
						1500mm
LED 500 x6 Uni. LED 300 x2 Uni. (In 2000mm sides)		LED 500 x6 Uni. LED 300 x4 Uni. (In 2500mm sides)		LED 500 x8 Uni. LED 300 x4 Uni. (In 3000mm sides)		
Pw. 150W/24V x1 Uni.	1 x Transverse Reinforc.	Pw. 150W/24V x1 Uni.	1 x Transverse Reinforc.	Pw. 200W/24V x1 Uni.	2 x Transverse Reinforc.	
* 13.327	<input type="checkbox"/>	* 13.328	<input type="checkbox"/>	* 13.329	<input type="checkbox"/>	

EN	Aluminium profile with or without light system suitable for indoor/ outdoor assembly canvas. Specially designed for large areas.
FR	Système de profil approprié pour toiles géantes ou de grandes aires. Disponible avec ou sans lumière, pour l'extérieur ou l'intérieur.
PT	Sistema de perfil com iluminação para impressões de grande formato ou grandes superfícies. Adequado para interior o exterior.
ES	Sistema de perfil adecuado para lonas gigantes o grandes áreas. Disponible con o sin sistema de luz y adecuado para exterior e interior.

CANVAS TEXTFIX LIGHT PROFILE (BIG SIZES)



available with or without LED light



INFORMATION

*mm

- Click system frame available with or without LED System. Each Canvas Kit contains: Aluminium profiles, hanger canvas, corner connections, Led systems, power supply.
- The Power supplies are always placed outside the aluminium frame of the TexFix.
- Ideal for giant prints destined for out-of-home campaigns. It has a simple banner attachment system for banners destined either for outdoor or indoor environments. In many different applications, and specially designed for large areas, TexFix Canvas can provide the answer for a smarter, better customized banner framing solution.
- TexFix Canvas is supplied in 3 standard kit sizes. There is a full range of possibilities, each suited to specific applications. Contact us for more details and information.

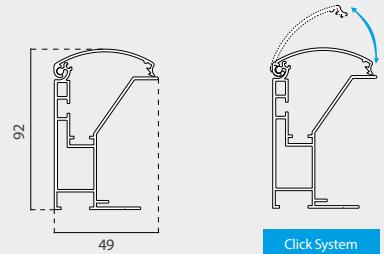

Click System



CANVAS TEXTFIX LIGHT PROFILE (BIG SIZES)

available with or without LED light



STANDARD SIZES

CANVAS T.L.	GRAPHIC SIZE
13.737	550x1300mm
13.738	1050x2540mm
13.739	1150x5040mm



*This Canvas Textfix does not include the power cable connector

HANGERS FOR CANVAS GRAPHIC



HANGER *mm

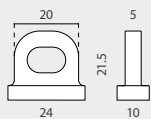

WALL HANGERS FOR CANVAS



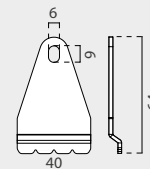

INFORMATION *mm

Wall Hanger for Canvas is suitable for being used with the next profiles:
 TexFix Canvas
 TexFix 80
 TexFix UltraSlim



HANGERS

13.334 x10 

HANGER	QTY	N.W	G.W	C.B.M	SIZE
Packing	4	0.31kg	0.45kg	0.0004	85x45x15mm
13.708				x4 	

FAST TEXTFIX DOUBLE-SIDED 120x42mm

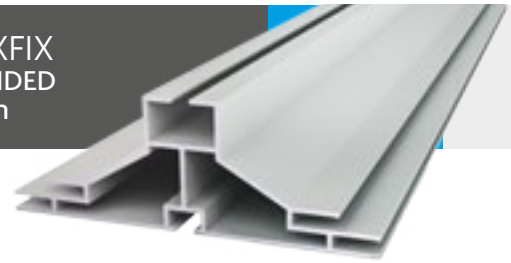

simple set-up

- EN Double-sided aluminum profile for frames. Textile digital printing.
- FR Profil double en aluminium pour des impressions digitales en textile.
- PT Perfil dupla face em alumínio para colocação de impressões têxteis digitais.
- ES Perfil doble de aluminio para elaborar marcos. Impresión digital sobre textil.

double sided

INFORMATION

*mm

- Featuring 120x42mm double sided profile frame design.
- Fast TexFix is really simple and quick to assemble.
- It's ideal for wall mounting at showrooms, exhibitions or windows/shop dressing.

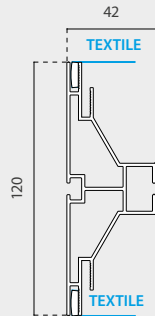

ALUMINIUM PROFILE SIZES

FAST TEXTFIX		SIZE
13.492		2 Uni. x 500mm
13.491		2 Uni. x 1000mm
13.490		2 Uni. x 2000mm
13.489		2 Uni. x 3000mm

FAST CORNER CONNECTOR

- EN Corner connector.
- FR Connexion d'angle.
- PT Esquina.
- ES Esquinero.



CORNER CONNECTOR

*mm

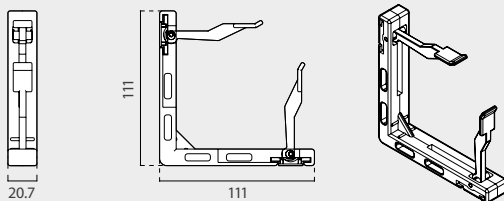

FAST CORNER

13.493 x4 



*Printed on fabric.
Impression sur toile.
Impressão em tecido.
Impresión en tela.

FLAT TEXTFIX | Flat Double Sided Frame Profile

- EN Double-sided aluminum profile for frames. Textile digital printing.
- FR Profil double en aluminium pour des impressions digitales en textile.
- PT Perfil dupla face em alumínio para colocação de impressões têxteis digitais.
- ES Perfil doble de aluminio para elaborar marcos. Impresión digital sobre textil.

FLAT TEXTFIX
DOUBLE-SIDED
120x20.5mm

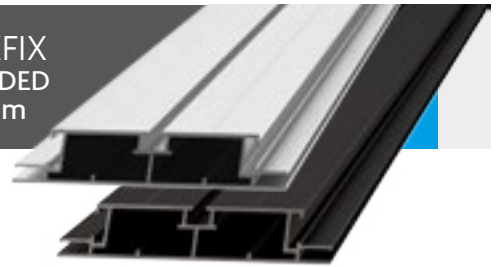

silver or
black color
available



*Printed on fabric.
Impression sur toile.
Impressão em tecido.
Impresión en tela.



INFORMATION

*mm

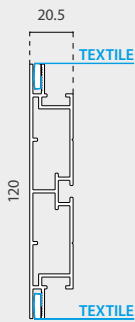
- Featuring 120x20.5mm double sided profile frame design.
- Fast TextFix is really simple and quick to assemble.
- It's ideal for wall mounting at showrooms, expositions or windows/shop dressing.



ALUMINIUM PROFILE SIZES

FLAT TEXTFIX			SIZE
13.650			 2 Uni. x 2000mm
13.651			 2 Uni. x 3000mm
13.652			 2 Uni. x 4000mm

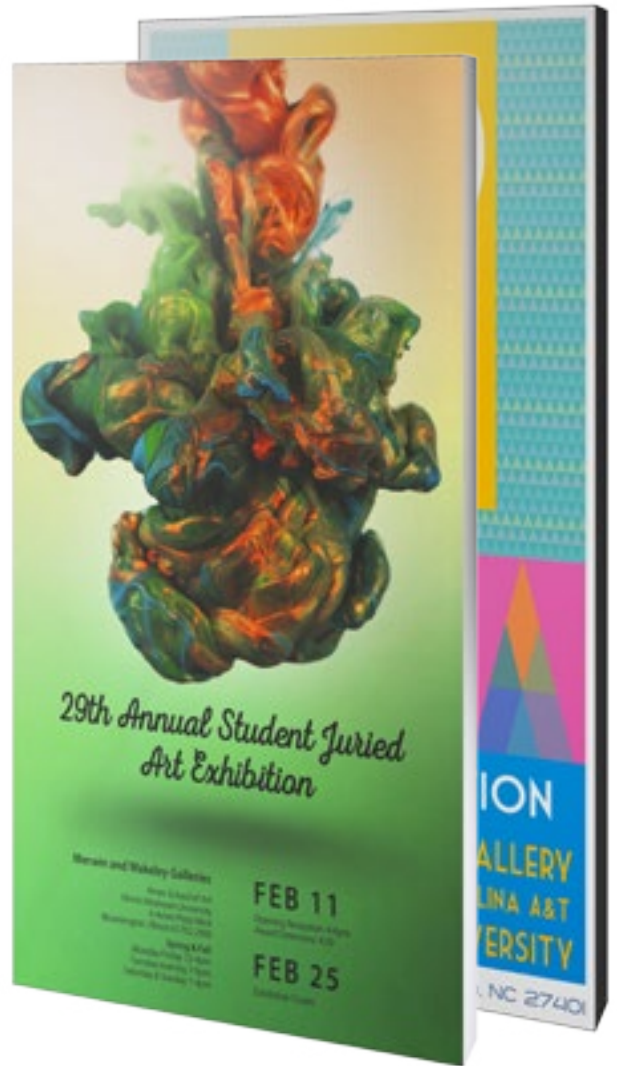

simple
set-up



CORNER

 13.333

x20 

CORNER CONNECTORS

CONNECTOR *mm

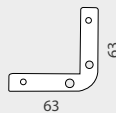

TEXFIX FRAME
DOUBLE-SIDED 150mm

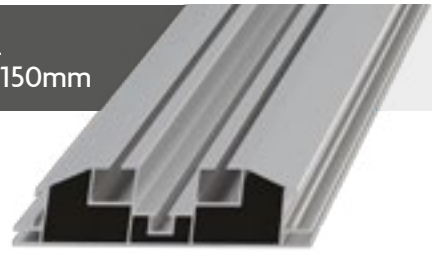

NEW

double sided

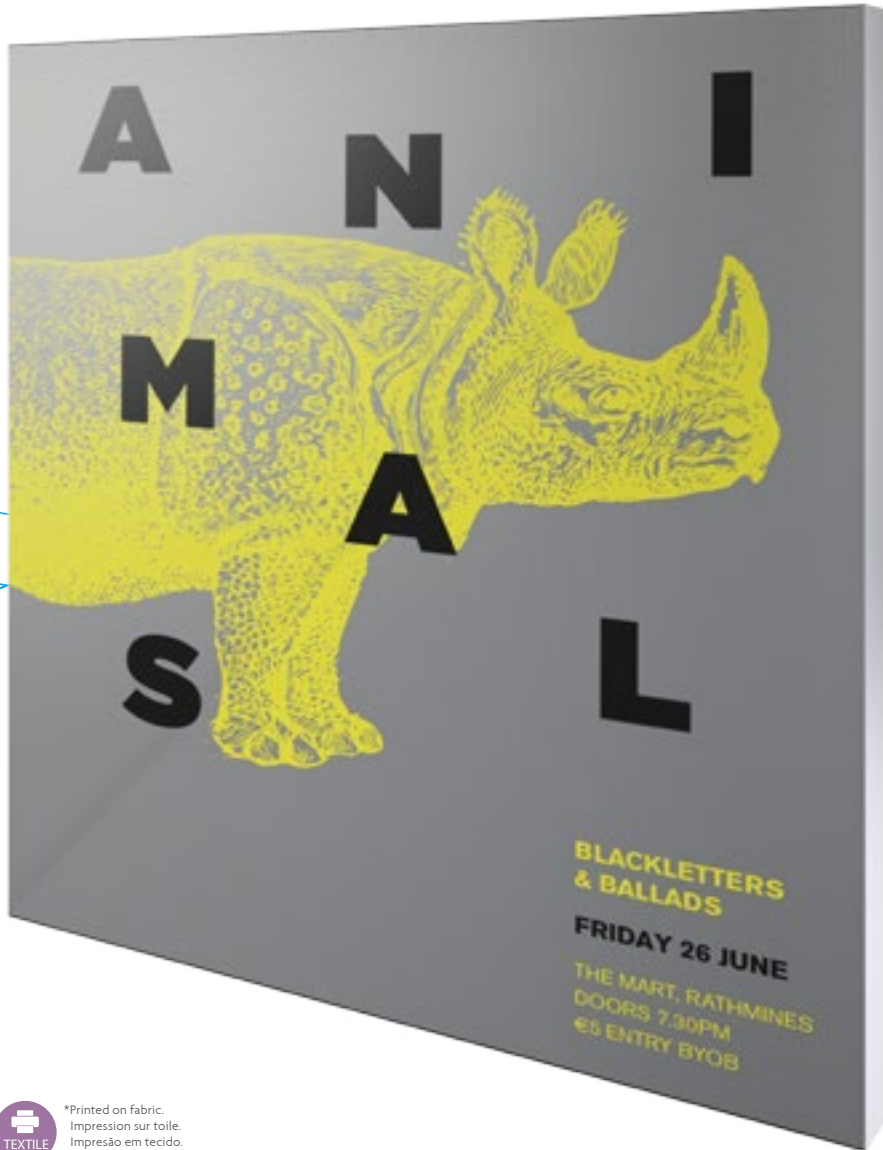

*Printed on fabric.
Impression sur toile.
Impressão em tecido.
Impresión en tela.

ALUMINIUM PROFILE SIZES

150mm		SIZE
13.653		 2 Uni. x 2000mm
13.654		 2 Uni. x 3000mm
13.655		 2 Uni. x 4000mm

INFORMATION

*mm

- This set includes: 4 Double-sided profiles, 4 corners and 1 Allen key.
- It's perfectly suitable for dressing and setting up shops, showrooms, offices and fair stands, displaying it as a totem using feet bases available next in TexFix accessories.

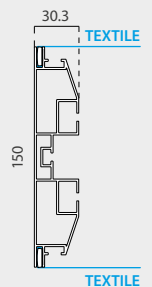

CORNER CONNECTORS



CORNER

13.333

x20

CONNECTOR *mm

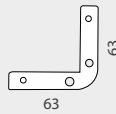

CORNER CONNECTORS



CORNER 40x40

13.243

x20

CONNECTOR *mm

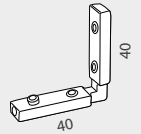

CORNER CONNECTOR

*mm

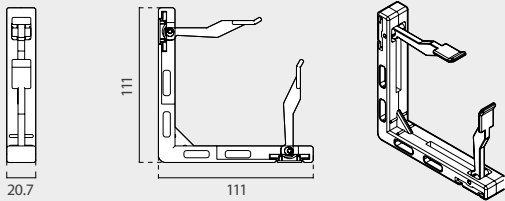

FAST CORNER CONNECTOR

EN Corner connector.

FR Connexion d'angle.

PT Esquina.

ES Esquinero.

FAST CORNER

13.493

x4

NEW

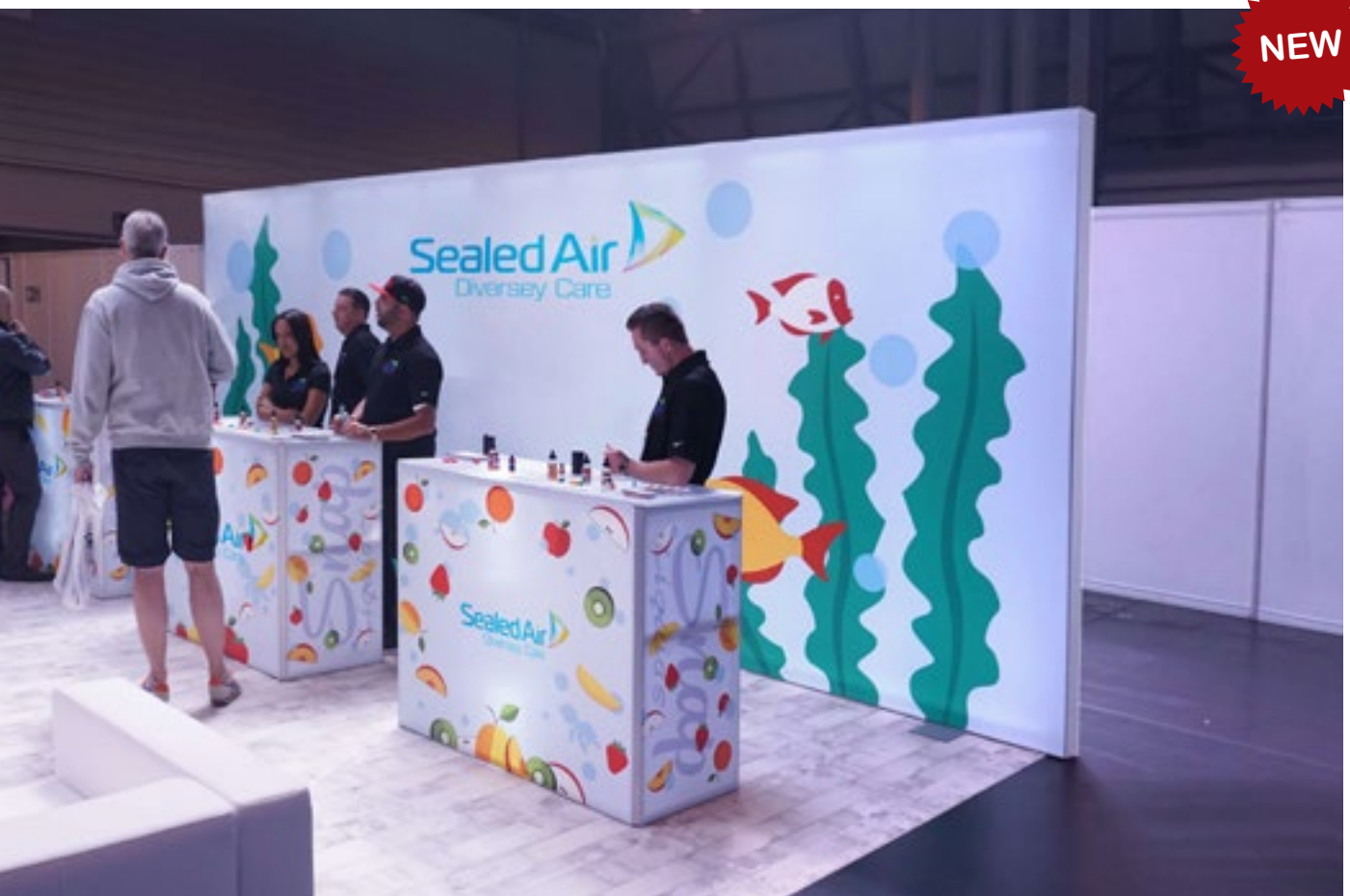

TEXFIX FRAME
41mm FOR STANDS

41mm PROFILE
FOR STANDS

PROFILE *mm

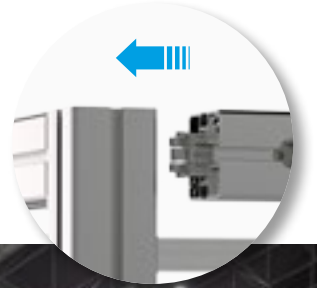
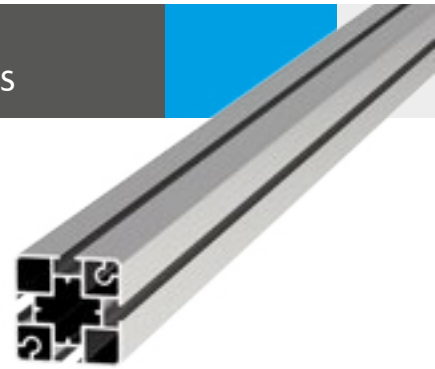
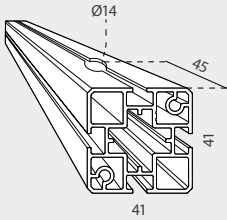

INFORMATION

This range of Aluminum Profiles, its flexibility allows for the creation of stands, such as point of sale units, light boxes, display stands, cabinets, double deck, showcases, custom modular exhibition stand and retail interior. These 41mm profiles are made of anodized aluminium. Each pack includes 2 aluminium 41mm profile bars (3 sizes available).

ALUMINIUM PROFILE SIZES

41 PROFILE		SIZE
13.660		2 Uni. x 2000mm
13.661		2 Uni. x 3000mm
13.662		2 Uni. x 4000mm



BASES FOR
41mm PROFILE

INFORMATION | ASSEMBLY

These bases for 41mm profiles are made of 4mm thickness steel sheet, with grey lacquered finish (Ral 9006). Each pack includes 2 Bases with screws and Leveling feet included.

1. 41mm profile
2. Metallic base
3. M4.8 L50 screws
2. Leveling foot M8

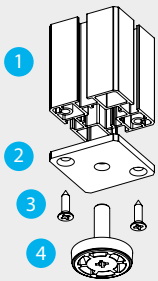

each pack contains 2 bases

41mm BASES

41 BASE		
13.663		x2 

LOCK

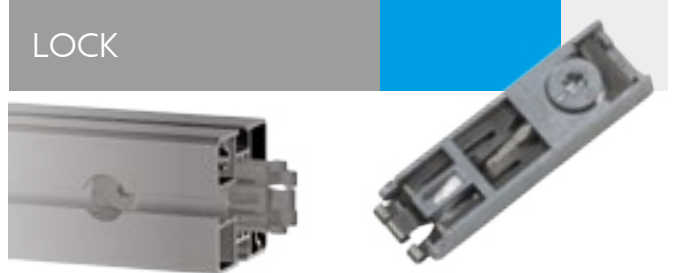



INFORMATION

*mm

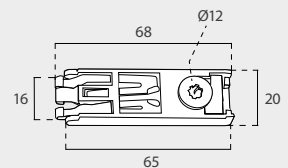
This Lock is suitable for connecting frames of TexFix structures with the Central Connector Profiles, providing a stable TexFix profile structure. With an easy and fast set up.



LOCK

13.244		x2 
--------	---	---

TEXFIX FRAME
105mm FOR STANDS

105mm PROFILE
FOR STANDS

PROFILE *mm

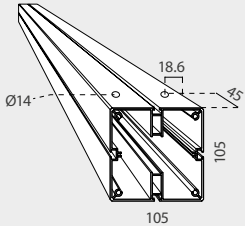

INFORMATION

This range of Aluminum Profiles, its flexibility allows for the creation of stands, such as point of sale units, light boxes, display stands, cabinets, double deck, showcases, custom modular exhibition stand and retail interior. These 105mm profiles are made of anodized aluminium. Each pack includes 2 aluminium 105mm profile bars (3 sizes available).

ALUMINIUM PROFILE SIZES

105 PROFILE	SIZE
13.656	2 Uni. x 2000mm
13.657	2 Uni. x 4000mm
13.658	1 Uni. x 6000mm



BASES FOR
105mm PROFILE

INFORMATION | ASSEMBLY

These bases for 105mm profiles are made of 4mm thickness steel sheet, with grey lacquered finish (Ral 9006). Each pack includes 2 Bases with screws and Leveling feet included.

1. 105mm profile
2. Metallic base
3. M5.5 L60 screws
2. Leveling foot M10

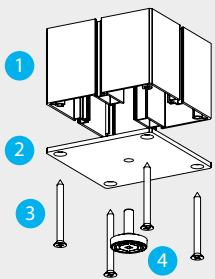

105mm BASES

105 BASE	
13.659	x2 

LOCK



INFORMATION

*mm

This Lock is suitable for connecting frames of TexFix structures with the Central Connector Profiles, providing a stable TexFix profile structure. With an easy and fast set up.

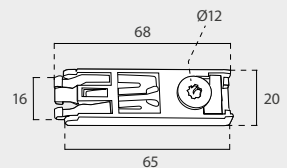

LOCK	
 13.244	x2 

HANGER FOR FRAME 16mm

HANGER *mm

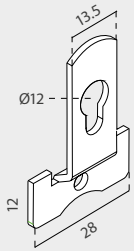

HANGERS 16	QTY	N.W	G.W	C.B.M	SIZE
Packing	20	0.31kg	0.45kg	0.0004	85x45x115mm
13.172			x20 		

HANGER RING CLIP

HANGER *mm

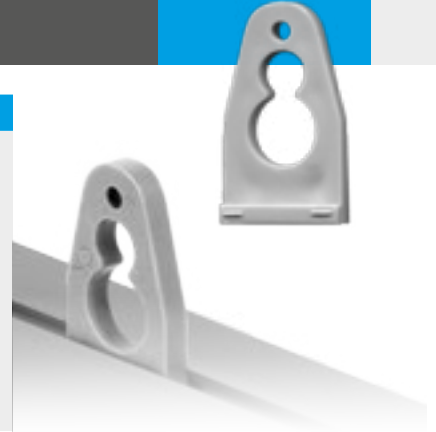
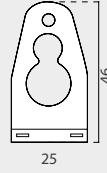

HANGERS	QTY	N.W	G.W	C.B.M	SIZE
Packing	10	0.04kg	0.10kg	0.0004	65x10x65mm
10.197			x10 		

CORNER CONNECTOR 36x36mm

CONNECTOR *mm

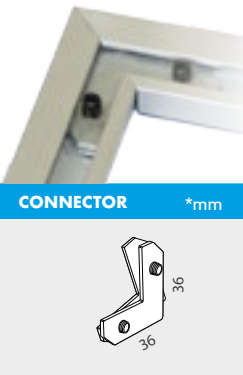
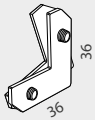

CORNER 1	QTY	N.W	G.W	C.B.M	SIZE
Packing	20	0.04kg	0.06kg	0.0004	36x36x10mm
13.171			x20 		

CORNER CONNECTOR 40x40mm

CONNECTOR *mm

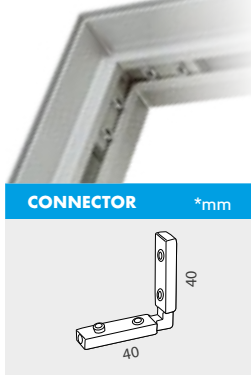
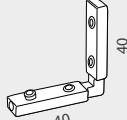

CORNER 40x40	QTY	N.W	G.W	C.B.M	SIZE
Packing	20	0.04kg	0.06kg	0.0004	40x40x10mm
13.243			x20 		

CORNER CONNECTOR 63x63mm

CONNECTOR *mm

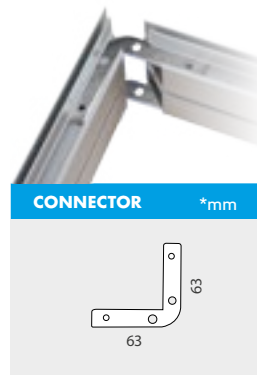
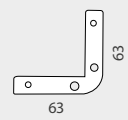

CORNER 1	QTY	N.W	G.W	C.B.M	SIZE
Packing	20	0.04kg	0.06kg	0.0004	63x63x10mm
13.333			x20 		

SILICONE STRIP

INFORMATION

- White silicone ± 12mm width.
- The silicone strip, once sewn to the fabric, allows to create a guide which is inserted into the grid of the profile being tight and perfectly framed.



SILICONE STRIP	QTY	N.W	G.W	C.B.M	SIZE
Packing	1	0.45kg	0.52kg	0.0021	100x80x265mm
13.173			10m./l		

STRAIGHT BASE



available in black or silver

BASE 'S'



available in black or silver

INFORMATION

*mm

- Stable bases for Textfix, available in black or silver color.

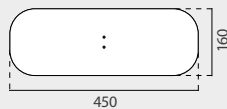



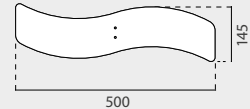

INFORMATION

*mm

- Stable bases for Textfix, available in black or silver color.



BASE STRA.	QTY	N.W	G.W	C.B.M	SIZE
Packing	1	5.9kg	6.1kg	0.0031	175x35x510mm
13.175		160x450mm		x2	

BASE 'S'	QTY	N.W	G.W	C.B.M	SIZE
Packing	1	4.5kg	4.7kg	0.0031	175x35x510mm
13.174		145x500mm		x2	

BOWTIE TEXTFIX BASE

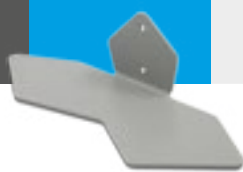

made of steel



2 ways of used



*included

FIN TEXTFIX BASE



made of steel



2 ways of used



*included

INFORMATION

*mm

- Made of Steel of 4mm of thickness, grey color (RAL 9006). It can be used in 2 ways (in or out). It has protective round pads at the bottom.

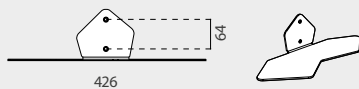



INFORMATION

*mm

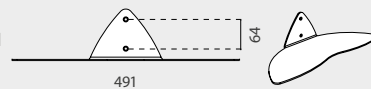
- Made of Steel of 4mm of thickness, grey color (RAL 9006). It can be used in 2 ways (in or out). It has protective round pads at the bottom.





BOW BASE	QTY	N.W	G.W	C.B.M	SIZE
Packing	1	2.1kg	5.07kg	0.0143	521x200x137mm
13.474		Width: 426mm		x2	

FIN BASE	QTY	N.W	G.W	C.B.M	SIZE
Packing	1	2.38kg	5.07kg	0.0143	521x200x137mm
13.480		Width: 491mm		x2	

STANDARD SIZES

CENTRAL	SIZE
13.342	600mm x2 
13.343	700mm x2 
13.344	1000mm x2 
13.345	1500mm x2 
13.346	2000mm x2 
13.347	2500mm x2 
13.348	3000mm x2 

LINEAR METERS

CENTRAL	QTY	N.W	G.W	C.B.M	SIZE
Packing	4	5.05kg	5.40kg	0.0147	75x65x3020mm
 13.246			4 Uni. x 3m/l=12m/l		

CENTRAL CONNECTOR PROFILE



INFORMATION

This Central Connector Profiles is ideal for connecting frames of TexFix structures. 7 Standard sizes available and also, linear meters option is available. It is made of aluminium. Suitable for being used with Lock.

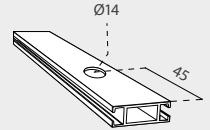

LOCK



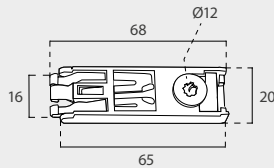

INFORMATION

This Lock is suitable for connecting frames of TexFix structures with the Central Connector Profiles, providing a stable TexFix profile structure. With an easy and fast set up.



LOCK

 13.244	x2 
--	--

CABLE HOLDER FOR TEXFIX





NEW

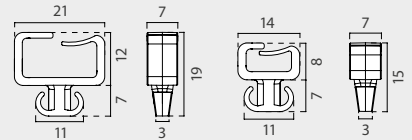

INFORMATION

These Cable Holder are ideal for being used with the interior cable of TexFix Frames. 2 sizes are available.



HOLDER 21	QTY	N.W	G.W	C.B.M	SIZE
Packing	1	0.016kg	0.25kg	0.0003	170x100x15mm
 13.772	x20 				
HOLDER 14	QTY	N.W	G.W	C.B.M	SIZE
Packing	1	0.008kg	0.015kg	0.0003	170x100x15mm
 13.773	x20 				

WALL HANGERS FOR CANVAS

INFORMATION

Wall Hanger for Canvas is suitable for being used with the next profiles: TexFix Canvas, TexFix 80, TexFix UltraSlim

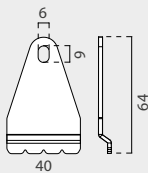



WALL HANGER FOR TEXFIX 100-150

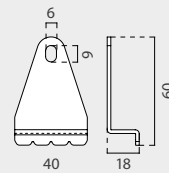

NEW

INFORMATION

This Hanger for TexFix is suitable for being used with the next profiles: TexFix 100, TexFix Flat 100, TexFix 150



CENTRAL	QTY	N.W	G.W	C.B.M	SIZE
Packing	4	0.31kg	0.45kg	0.0004	85x45x115mm
 13.708	x4 				

CENTRAL	QTY	N.W	G.W	C.B.M	SIZE
Packing	1	0.135kg	0.145kg	0.0003	170x100x15mm
 13.774	x4 				

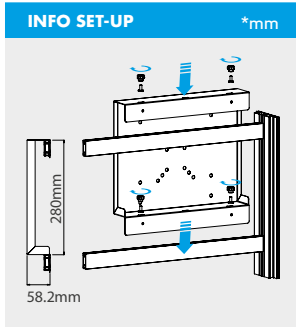

TV SUPPORT	QTY	N.W	G.W	C.B.M	SIZE
Packing	1	1.67kg	1.95kg	0.0084	365x355x65mm
13.597				x1	

TV SUPPORT FOR TEXFIX 100mm



adjusting screws are included



INFORMATION

This TV Support for TexFix is suitable for being used with 100mm profiles. Set up is very simple, it hangs from Central Connector Profiles and it adjusts thanks its screws (included). Ideal for displaying media promotions through TV Panels.



STEEL TRAYS

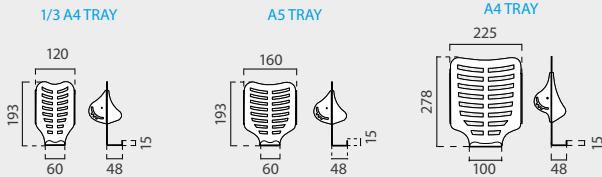

1/3 A4 TRAY	QTY	N.W	G.W	C.B.M	SIZE
Packing	1	0.55kg	0.80kg	0.003	240x130x120mm
13.440	Left	1/3 A4		x2	
13.441	Right	1/3 A4		x2	

A5 TRAY	QTY	N.W	G.W	C.B.M	SIZE
Packing	1	0.70kg	0.85kg	0.005	240x175x120mm
13.442	Left	A5		x2	
13.443	Right	A5		x2	

A4 TRAY	QTY	N.W	G.W	C.B.M	SIZE
Packing	1	1.25kg	1.60kg	0.009	330x240x120mm
13.444	Left	A4		x2	
13.445	Right	A4		x2	

STEEL TRAY FOR TEXFIX 100



3 adjustable angles

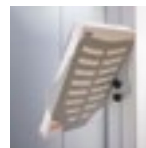

QUICK SYSTEM | Quick System

EN Quick System is great for the exhibition of products, displays and many different visual needs. Quick and easy assembly.

FR Système d'exhibition idéal pour l'exposition d'affiches, produits liés à la communication. Rapide et facile à monter.

PT Este sistema é ideal para a exibição de produtos, imagens ou outras possibilidades de comunicação. Montagem fácil e simples.

ES Sistema de exhibición ideal para exposición de carteles, productos y distintas necesidades de comunicación. Fácil y rápido montaje.

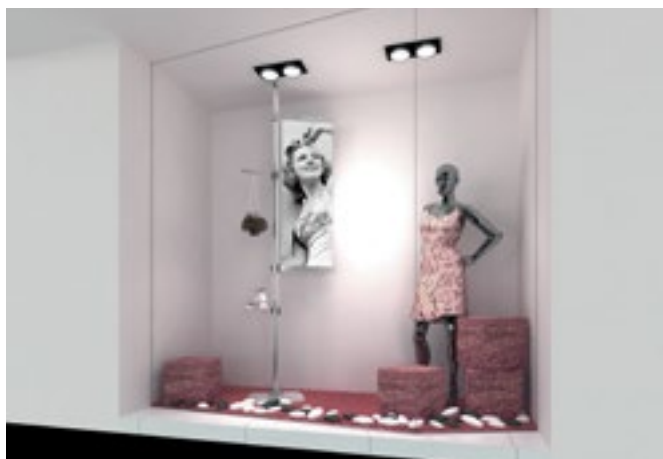



TELESCOPIC POLE

aluminium pole system

1200 POLE

*mm

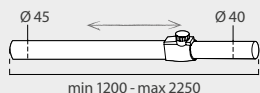

1500 POLE

*mm

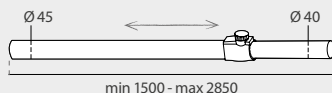

2000 POLE

*mm

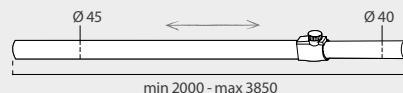

POLE1



10.961 Ø45x1200mm

POLE2



10.962 Ø45x1500mm

POLE3



10.963 Ø45x2000mm

7 WAYS CONNECTOR



CONNECTOR

*mm

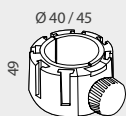

7 WAYS CONNECTOR

10.968-40 Ø40mm

10.968-45 Ø45mm

ALU BLOCK

ALU BLOCK

*mm

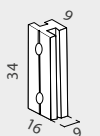

ALU BLOCK

10.969 x10

RAIL

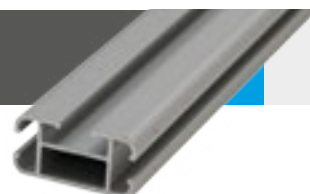

INFORMATION

*mm

- Combine it with:
- + pvc insert
- + end caps
- + connecting plate
- + side connecting block
- + back connecting block

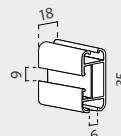

RAIL

10.970 Length: 2 meter

POLE'S END CAPS



CAP



END CAPS

10.966 x10

BASE CONNECTOR

*mm



BASE CONN.

10.967

screw to the base

SQUARE BASE

SQUARE BASE

*mm



SQUARE B.

10.964 380x380

FEET BASE

FEET BASE

*mm



FEET BASE

10.965

PVC INSERT

INFO *mm

- Stick it to the PVC Adhesive



PVC INSERT

10.862 Length: 2 meter

SIDE CONNECTING BLOCK

BLOCK *mm

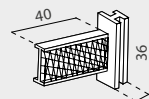

SIDE C.B.

10.863 x10

BACK CONNECTING BLOCK

INFO *mm

- Rail connection.

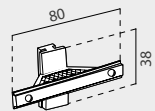

BACK C.B.

10.864 x10

END CAP

INFO *mm

- Connect it to a rail.
- Grey color finished.

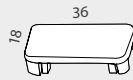

END CAP

10.971 x10

GRAPHIC CLIP

CLIP *mm



G.CLIP

10.539 Ø45mm x10

10.540 Ø40mm x10

WIRE CLIP

INFO *mm

- Wires holder.



WIRE CLIP

10.541 Ø45mm x10

10.542 Ø40mm x10

INFO *mm

- 19mm width.
- Front connection.

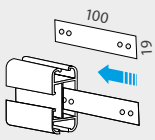

C.PLATE 19

10.972 x10 100x19mm

CONNECTING PLATE

INFO *mm

- 12mm width.
- Sideway connection.

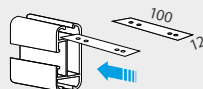

C.PLATE 12

10.973 x10 100x12mm

PLASTIC CLIP



INFO

- Plastic.
- Ideal for holding poster or banner.



PLASTIC CLIP

10.537

x10

SIDE CLIP



INFO

- Plastic.



SIDE CLIP

10.538

x10

ARC SHELF

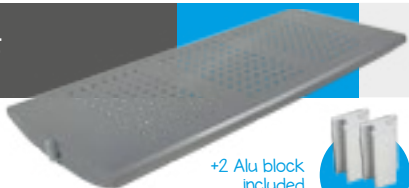

INFO

- Includes 2 Alu Block.

+2 Alu block included



10.969

10.959

828x350mm

SHELF

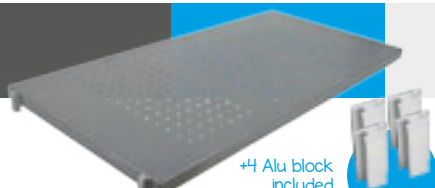

INFO

- Includes 4 Alu Block.

+4 Alu block included



10.969

10.960

825x400mm

LCD BRACKET



INFO

- Plastic.
- Includes 1 Alu Block.

+1 Alu block included



10.969

10.543



PANEL



INFO

- Metallic.
- Perforated.
- Includes 4 Alu Block.

+4 Alu block included



10.969

10.958

825x1000mm

all brochures holders include Alu Block



10.969

INFO

- Includes 1 Alu Block.
- For A4 size documents.



BROCH. A4

10.544

A4

INFO

- Includes 1 Alu Block.
- For A5 size documents.



BROCH. A5

10.545

A5

ACRYLIC BROCHURE HOLDER



INFO

- Includes 1 Alu Block.
- For A6 size documents.



BROCH. A6

10.546

A6

ARC LIGHT BOX



INFO

- Ideal for displaying your graphics.

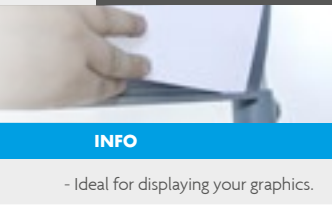

10.957

825x285mm

SPOTLIGHT



INFO

- With connecting base. Ideal for illuminating your exhibit booth and shed light on your products.

10.389

475x138mm

- EN Allows the fixing of supports up to 20mm. The maximum recommended height for the graphic is 1500mm. Allows the printing of any logo on both sides of the base.
- FR Permet l'utilisation de supports jusqu'à 20mm d'épaisseur. La hauteur maximale suggérée du visuel est de 1500mm. Possibilité d'inclure des logos sur les bases.
- PT Permite fixar painéis até 20mm de espessura. A altura máxima recomendada é de 1500mm. Possibilidade de colocar uma impressão em cada lado da base.
- ES Permite la sujeción de soportes hasta 20mm. La altura máxima recomendada para la gráfica es 1500mm. Permite colocar una impresión en ambos lados de la base.

PANELFIX WING STEEL





INFORMATION

*mm

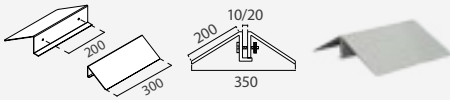
- Steel base designed to hold rigid graphs, creating a sturdy long lasting display.
- 300mm width base.





PFX 300	QTY	N.W	G.W	C.B.M	SIZE
Packing	1	2.75kg	2.95kg	0.0069	210x100x330mm
 10.065		Grey			300mm
 13.711		Black			

INFORMATION

*mm

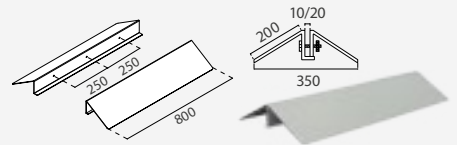
- Steel base designed to hold rigid graphs, creating a sturdy long lasting display.
- 800mm width base.





PFX 800	QTY	N.W	G.W	C.B.M	SIZE
Packing	1	7.15kg	7.95kg	0.0243	830x255x115mm
 13.713		Grey			800mm
 13.714		Black			

INFORMATION

*mm

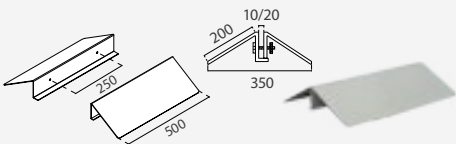
- Steel base designed to hold rigid graphs, creating a sturdy long lasting display.
- 500mm width base.





PFX 500	QTY	N.W	G.W	C.B.M	SIZE
Packing	1	4.55kg	4.85kg	0.011	210x100x330mm
 10.066		Grey			500mm
 13.712		Black			

INFORMATION

*mm

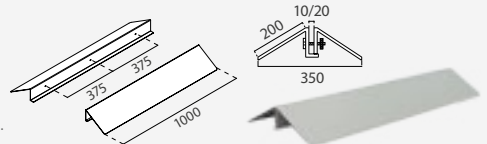
- Steel base designed to hold rigid graphs, creating a sturdy long lasting display.
- 1000mm width base.



PFX 1000	QTY	N.W	G.W	C.B.M	SIZE
Packing	1	8.85kg	9.85kg	0.0302	1030x255x115mm
 13.715		Grey			1000mm
 13.716		Black			

POSTER DISPLAY | Aluminium Bases

PANELFIX WING ALUMINIUM



- | | |
|----|--|
| EN | Depending on its placement, this can be used with maximum graphic thickness to 26mm. The maximum recommended height for the graphic is 1500mm. |
| FR | En fonction de sa position, il permet le maintien de supports maximum de 26mm d'épaisseur. La hauteur maximale suggérée du visuel est de 1500mm. |
| PT | Dependendo da posição, pode ser utilizado com painéis até 26mm de espessura. A altura máxima recomendada é de 1500mm. |
| ES | Dependiendo del ajuste de la base, puede ser empleada con gráficas de hasta 26mm de espesor. La altura máxima recomendada para la gráfica es 1500mm. |



FOR PANELS UP TO 18mm

- 1. Place the profile below.
- 2. Adjust the profile with wheel at the bottom of the PanelFix Wing Aluminium.
- 3. Max. thickness: 18mm.
- 4. Place the graphic panel into the slot and adjust it with the wheel until it is properly fixed.

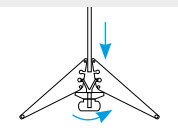
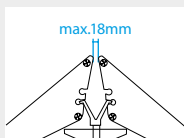
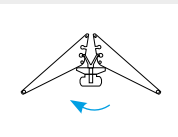
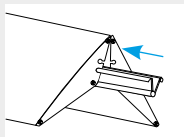

INSTALL EXPLANATION | ALUMINIUM BASES

FOR PANELS UP TO 26mm

- 1. Place the profile above.
- 2. Adjust the profile with wheel at the bottom of the PanelFix Wing Aluminium.
- 3. Max. thickness: 26mm.
- 4. Place the graphic panel into the slot and adjust it with the wheel until it is properly fixed.

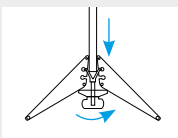
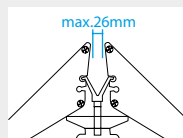
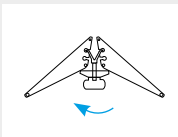
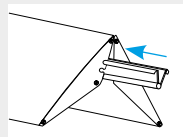

INFORMATION

*mm

- 200m width aluminium Base.
- 2 ways for adjusting the panels.
- Available in silver or black color.
- Allows the labeling on both sides.







- 350m width aluminium Base.
- 2 ways for adjusting the panels.
- Available in silver or black color.
- Allows the labeling on both sides.





- 550m width aluminium Base.
- 2 ways for adjusting the panels.
- Available in silver or black color.
- Allows the labeling on both sides.



PF	AL 200	QTY	N.W	G.W	C.B.M	SIZE
	Packing	1	1.1kg	1.5kg	0.0069	315x93x235mm
	10.828					200mm
	10.829					

PF	AL 350	QTY	N.W	G.W	C.B.M	SIZE
	Packing	1	2.6kg	3kg	0.0113	315x93x385mm
	10.877					350mm
	10.869					

PF	AL 550	QTY	N.W	G.W	C.B.M	SIZE
	Packing	1	4.15kg	4.6kg	0.0171	315x93x585mm
	10.880					550mm
	10.870					

PANELFIX WING
STEEL XXL





INFORMATION

*mm

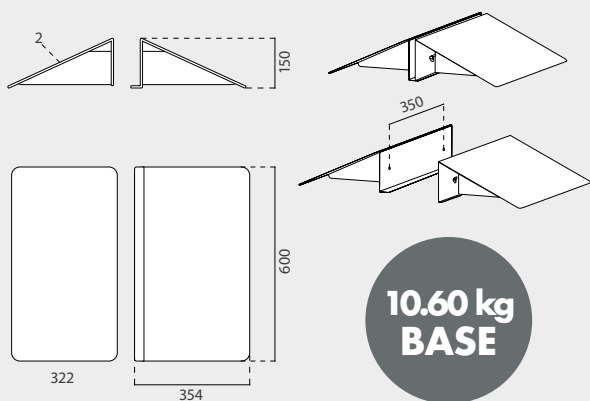
- Made of steel sheet of 2mm thickness.
- Black laquered (RAL 9005) or grey laquered (RAL 9006) are available.
- The XXL Steel base is ideal to hold rigid materials up to 19mm thickness.
- The maximum recommended height for the graphic board is 2000mm.
- Specially designed for supporting big graphic panels thanks to its 11.60kg.
- This base is a simple clip holder system that grips a board between the two sides to help businesses advertise their products and services. Ideal as a sleek, professional alternative to bulky A-frame Board poster stands.



PFIX XXL	QTY	N.W	G.W	C.B.M	SIZE
Packing	1	11.85kg	12.55kg	0.0486	400x190x640mm
 13.721		Grey			600x663x150mm
 13.722		Black			

MORALES XXL

NEW



INFORMATION

*mm

- Made of steel sheet of 5mm thickness.
- Black laquered (RAL 9005) or grey laquered (RAL 9006) are available.
- The XXL Steel base is ideal to hold rigid materials up to 19mm thickness.
- The maximum recommended height for the graphic board is 2000mm.
- Specially designed for supporting big graphic panels thanks to its 11.65kg.
- This base is a simple clip holder system that grips a board between the two sides to help businesses advertise their products and services. Ideal as a sleek, professional alternative to bulky A-frame Board poster stands.

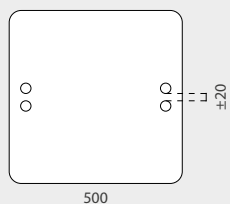
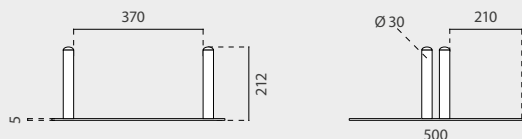

**10.65 kg
BASE**



MORALESXXL	QTY	N.W	G.W	C.B.M	SIZE
Packing	1	11.30kg	12.10kg	0.0772	545x545x260mm
 13.723		Grey			500x500x212mm
 13.724		Black			

BALBOA

EN	Steel support for placement of graphics up to 11mm thickness. Exterior Sizes: 295x295mm with 200mm high and 5mm base thickness.
FR	Base de acier de 5mm d'épaisseur. Mesures: 295x295mm et 200mm d'hauteur. Idéal pour l'exposition de visuels jusqu'à 11mm d'épaisseur.
PT	Base metálica com 5mm de espessura. Medidas 295x295mm e 200 mm de altura. Suporta impressões até 11mm de espessura. Aço.
ES	Base de 5mm de espesor. Medidas 295x295mm y 200mm de alto. Ideal para colocación de soportes gráficos de hasta 11mm de espesor. Acero.



available in black or white color



anti-scratch felt pads





INFORMATION

*mm

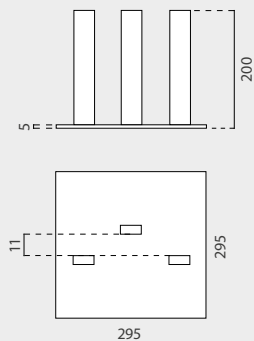
- Made of 5mm thickness steel sheet.
- With anti-scratch felt pads at bottom.
- Available in black or white colored.
- The steel base of this sign holder are sturdy enough for multiple uses and years to come, from a crowded trade show floor to a fast paced retail store.
- The Balboa base is ideal to hold rigid materials up to 11mm thickness.



BALBOA	QTY	N.W	G.W	C.B.M	SIZE
Packing	2	9.00kg	9.60kg	0.024	310x250x310mm
 10.894		295x295x200mm		x2	
 10.895					

EN	Steel Base support for the placement of graphics up to 10mm thickness. Sizes: 300mm diameter x 200mm high and x 5mm thickness.
FR	Base métallique en acier de 5mm d'épaisseur, 300mm de diamètre et 200mm de hauteur. Idéal pour l'exposition de visuels jusqu'à 10 mm d'épaisseur.
PT	Base em aço para colocar impressões com um máx. de 10mm de espessura. Tamanho: 300mm de diâmetro x 200mm de altura x 5mm de espessura.
ES	Base de acero de 5mm de espesor. 300mm de diámetro y 200mm de alto. Ideal para colocación de gráficas de hasta 10mm de espesor.







MONTIJO

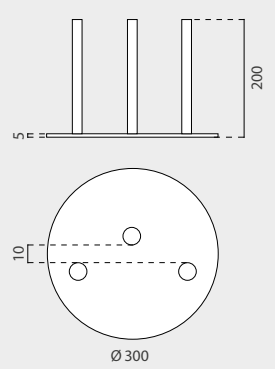

INFORMATION *mm

- Made of 5mm thickness steel sheet.
- With anti-scratch felt pads at bottom.
- Available in black or white colored.
- The steel base of this sign holder are sturdy enough for multiple uses and years to come, from a crowded trade show floor to a fast paced retail store.
- The Montijo is ideal for holding rigid materials up to 10mm thickness.



MONTIJO	QTY	N.W	G.W	C.B.M	SIZE
Packing	2	7.2kg	7.75kg	0.024	310x250x310mm
 10.898		Ø300x200mm		x2	
 10.838					



ARTWORK *mm

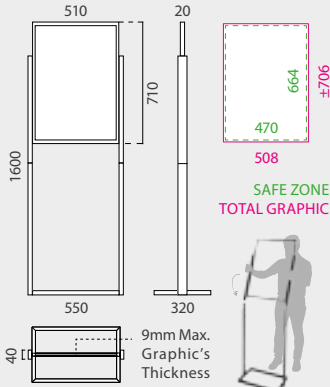

INFORMATION

Blackpainted. Slidetheposter(9mmmax. thickness) into the groove and display it back-to-back in high traffic areas.

STEEL D1	QTY	N.W	G.W	C.B.M	SIZE
Packing	1	8.65kg	9.55kg	0.0459	570x100x805mm

❁ 10.996 Graphic Size: 508 x ±706mm

STEEL DISPLAY



ARTWORK *mm

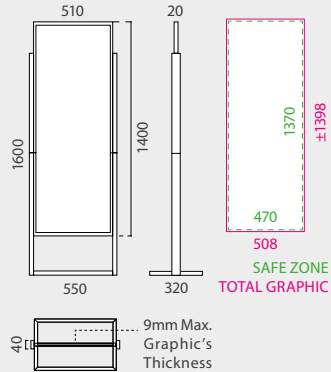

INFORMATION

Blackpainted. Slidetheposter(9mmmax. thickness) into the groove and display it back-to-back in high traffic areas.

STEEL D 2	QTY	N.W	G.W	C.B.M	SIZE
Packing	1	9.5kg	10.4kg	0.0459	570x100x805mm

❁ 10.997 Graphic Size: 508 x ±1398mm



ALUMINIUM BANNER DISPLAY

INFORMATION

ARTWORK *mm

Aluminium Banner Display is lacquered in grey RAL 9006 and features an easy to load and upload system. With an easy glide for the graphic poster (5mm maxi.thickness) into the metal grooves of the structure and display it back-to-back in high traffic areas. This Aluminium Banner Display is ideal for displaying at mall's corridors, for promoting at trade shows, outside your office or showroom.

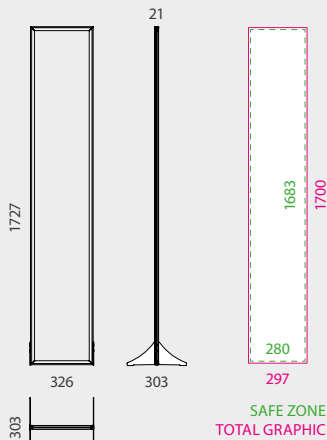

A.BANNER D.	QTY	N.W	G.W	C.B.M	SIZE
Packing	1	1.8kg	2.32kg	0.0205	1745x335x35mm

13.643 Graphic Size: 297x1700mm





INFORMATION **ARTWORK** *mm

Aluminium Stand Display is lacquered in grey RAL 9006 and features an easy to load and upload system. With adjustable stability sturdy feet and an easy glide for the graphic poster (9mm maxi. thickness) into the metal grooves of the structure and display it back-to-back in high traffic areas. The Aluminium Stand Display is ideal for promoting at trade shows, retail stores, fair stands, showrooms, travel agencies or offices.

VISUAL ZONE
TOTAL GRAPHIC

A.STAND D.	QTY	N.W	G.W	C.B.M	SIZE
Packing	1	4.47kg	5.54kg	0.0436	880x660x75mm
13.736	Graphic Size: 500x1400mm				

ALUMINIUM STAND DISPLAY



INFORMATION **ARTWORK** *mm

Aluminium Board Display is lacquered in grey RAL 9006 and features an easy to load and upload system. With adjustable stability sturdy feet and an easy glide for the graphic poster (9mm maxi. thickness) into the metal grooves of the structure and display it back-to-back in high traffic areas. The Aluminium Board Display is ideal for promoting at trade shows, outside your office or showroom.

VISUAL ZONE
TOTAL GRAPHIC

A.BOARD D.	QTY	N.W	G.W	C.B.M	SIZE
Packing	1	3.29kg	4.48kg	0.0436	880x660x75mm
13.598	Graphic Size: 500x700mm				

ALUMINIUM BOARD DISPLAY



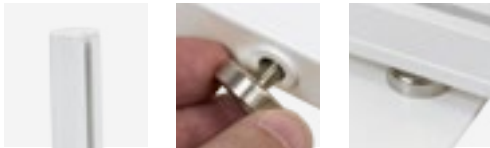

OPEN ALUMINIUM MAGNETIC SUPPORT



max. graphic
thickness:
5mm



INFORMATION

*mm

This open white painted aluminium frame support and features an easy glide for the graphic poster (5mm maxi. thickness). Also, it features 2 magnetic supports at the bases. Ideal for promoting on shelves at malls or at the supermarkets.

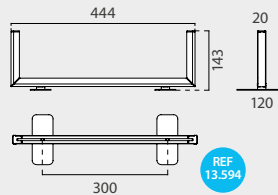

REF 13.594

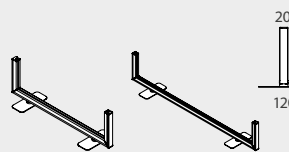

REF 13.589

OPEN M.S.444	QTY	N.W	G.W	C.B.M	SIZE
Packing	2	0.94kg	1.08kg	0.0026	480x180x30mm
13.594	Graphic Width: 420mm		x2 		

OPEN M.S.724	QTY	N.W	G.W	C.B.M	SIZE
Packing	2	1.12kg	1.27kg	0.0041	760x180x30mm
13.589	Graphic Width: 700mm		x2 		



CLOSED ALUMINIUM MAGNETIC SUPPORT

max. graphic thickness: 5mm



INFORMATION

*mm

This closed silver aluminium frame support features an easy glide for the graphic poster (5mm maxi. thickness). Also, it features 2 magnetic supports at the bases. Ideal for promoting on shelves at malls or at the supermarkets.

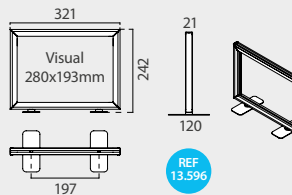

REF 13.596

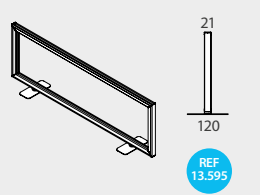

REF 13.595

CLOSED M.S.321	QTY	N.W	G.W	C.B.M	SIZE
Packing	2	1.5kg	1.61kg	0.0046	335x250x55mm
13.596	Graphic Size: 298x220x5mm		x2 		

CLOSED M.S.724	QTY	N.W	G.W	C.B.M	SIZE
Packing	1	0.88kg	1kg	0.0055	735x250x30mm
13.595	Graphic Size: 700x220x5mm		x2 		

MEDIA FRAME



 magnetic fixing

* PVC sheet and magnetic tape not included

anti-scratch felt pads



INFORMATION

*mm

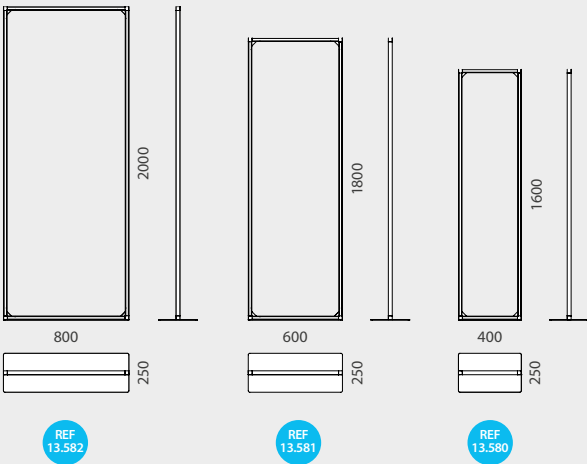

This closed frame support is made of aluminium and it is suitable for PVC graphic posters, fixed with magnetic tape. Also, it features a stylish and sturdy flat base. Media Frame is ideal for using during a variety of promotional events, such as trade shows, media events, expositions or even as solution for a photocall.



MEDIA F. 400	QTY	N.W	G.W	C.B.M	SIZE
Packing	1	7.5kg	8kg	0.0178	410x860x60mm
 13.580	Graphic Size: 400x1600mm				
MEDIA F. 600	QTY	N.W	G.W	C.B.M	SIZE
Packing	1	10kg	11kg	0.0295	610x950x60mm
 13.581	Graphic Size: 600x1800mm				
MEDIA F. 800	QTY	N.W	G.W	C.B.M	SIZE
Packing	1	13kg	14kg	0.0436	1070x810x60mm
 13.582	Graphic Size: 800x2000mm				

* PVC sheet and magnetic tape not included.

VILAMOURA EXTENSION BANNER

EN	Adjustable height and width structure. • Min. graphic size: \pm Height 860 x Width 1270mm. • Max. graphic size: \pm Height 2350 x Width 2445mm.
FR	Banner extensible avec différents tailles de visuel. • Min. des visuels: \pm Hauteur 860 x Largeur 1270mm. • Max. des visuels: \pm Hauteur 2350 x Largeur 2445mm.
PT	Expositor ajustável em altura e comprimento. • Impressão mín.: \pm Altura 860 x Largura 1270mm. • Impressão máx.: \pm Altura 2350 x Largura 2445mm.
ES	Alto y ancho ajustables a distintos tamaños de gráfica. • Área gráfica mínima: \pm 860mm alto x 1270mm ancho. • Área gráfica máxima: \pm 2350mm alto x 2445mm ancho.

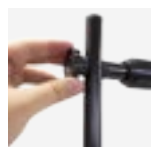

adjustable
height and width



max. graphic size:
2445x2350mm

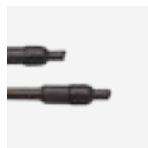

easy to transport



INFORMATION

With structure made of steel and black laquered. This portable and double-sided banner is ideal for using during a variety of promotional events, such as a trade show, media event, tradeshow exposition or even as solution for a photocall. Each pipe is also designed for an easy and fast telescopic adjustment of the display, allowing the use of graphs of different widths and heights. Vilamoura banner is a display fast to assemble and easy to transport, ideal for any promotional event that your business requires.

VILAMOURA	QTY	N.W	G.W	C.B.M	SIZE
Packing	1	6.6kg	8kg	0.027	240x115x1000mm

10.498

ARTWORK

*mm

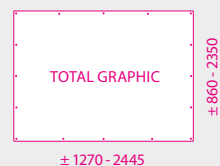
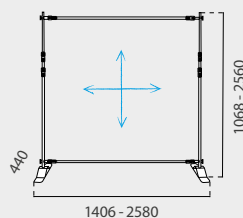

VILAMOURA XXL EXTENSION BANNER



EN	Adjustable height and width structure. • Min. graphic size: \pm Height 1315 x Width 1780mm. • Max. graphic size: \pm Height 2535 x Width 3355mm.
FR	Banner extensible avec différents tailles de visuel. • Min. des visuels: \pm Hauteur 1315 x Largeur 1780mm. • Max. des visuels: \pm Hauteur 2535 x Largeur 3355mm.
PT	Expositor ajustável em altura e comprimento. • Impressão mín.: \pm Altura 1315 x Largura 1780mm. • Impressão máx.: \pm Altura 2535 x Largura 3355mm.
ES	Altura y anchura ajustables a distintos tamaños de gráfica. • Área gráfica mínima: \pm 1315mm alto x 1780mm ancho. • Área gráfica máxima: \pm 2535mm alto x 3355mm ancho.

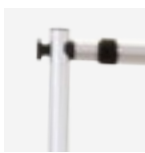

adjustable height and width



max. graphic size:
3355x2535mm



easy to transport



INFORMATION

With structure made of aluminium and plastic. Available black or silver finishing. This portable and double-sided banner is ideal for using during a variety of promotional events, such as a trade show, media event, tradeshow exposition or even as solution for a photocall. Each pipe is also designed for an easy and fast telescopic adjustment of the display, allowing the use of graphs of different widths and heights. Vilamoura XXL banner is a big size display fast to assemble and easy to transport, ideal for any promotional event that your business requires.

VILAMOURA XXL	QTY	N.W	G.W	C.B.M	SIZE
Packing	1	7kg	8.1kg	0.0266	230x110x1050vmm
	13.752				

ARTWORK

*mm

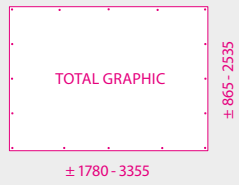
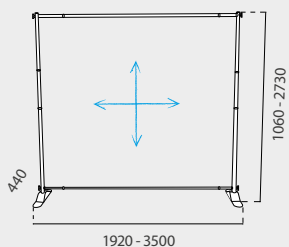

ALGORA

suitable for 2 sided posters

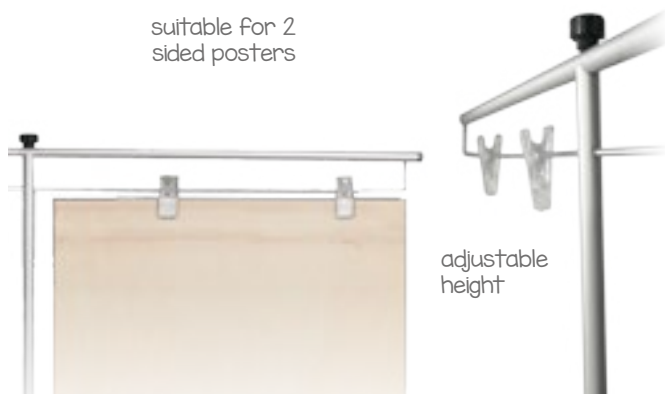

adjustable height

INFORMATION

ARTWORK *mm

Made of metal, this double sided Poster Display is suitable for 2 graphic exhibitions. With a telescopic pole (adjustable height of 1000-1600mm).

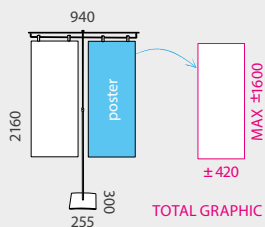

telescopic

ALGORA	QTY	N.W	G.W	C.B.M	SIZE
Packing	1	1.2kg	1.6kg	0.02	270x70x1200mm

❄️ 10.803 Graphic Size: ±420x1000-1600mm (x2)

OROPESA



designed for an optimum storage



INFORMATION

ARTWORK *mm

Oropesa Poster Display is made of metal, featuring a special design for an optimum storage. Also, it has a telescopic pole with adjustable height (1100-2100mm). Ideal for promoting your bussines, such as tradeshows and promotional events at stores or business presentations.

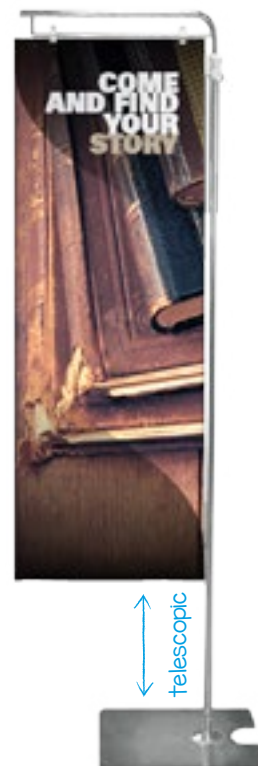
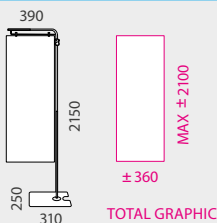

telescopic

OROPESA	QTY	N.W	G.W	C.B.M	SIZE
Packing	1	1.96kg	2.53kg	0.05	410x118x1185mm

❄️ 10.432 Graphic Size: ±360x1100-2100mm

PROMOTION COUNTERS | Promotion Counters

EN Promotion counters for tradeshows, selling points, etc. Quick and easy assembly. Fully removable. The carry bag is included.

FR Comptoir d'accueil pour point de vente. Rapide et facile à monter. Totalement démontable. Valise de transport incluse.

PT Balcões promocionais para ponto de venda. Montagem fácil e rápida. Totalmente desmontáveis. Inclui saco de transporte.

ES Mostradores para promoción en punto de venta. Fácil y rápido montaje. Totalmente desmontables. Incluyen bolsa de transporte.



+ header
+ carry bag

+ 1 interior shelf

TAVIRA



INFORMATION

This counter comes with carry bag and exhibitors can quickly assemble it in less than 5 minutes (no tools required). Once it has been assembled, the counter is lightweight enough to be moved with ease by one person. It has 1 plastic shelf in the interior of the display, so the extra brochures, business cards and flyers can be stored out of sight so your exhibition always appears clean and organized. This counter has a header of 803x300mm for displaying company logos or graphs. Each counter that comes with a header is excellent for tradeshows and promotional events at stores or business presentations.

EXTERNAL SIZE

ARTWORK

*mm

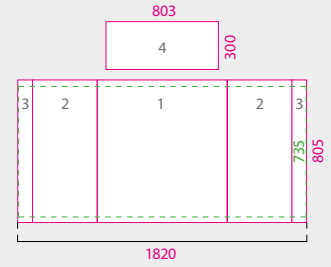
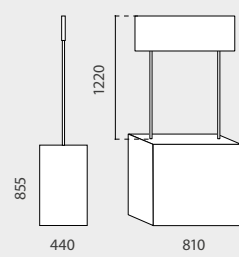

1: 820x805mm 3: 115x805mm
2: 385x805mm 4: 803x300mm

SAFE ZONE
TOTAL GRAPHIC

TAVIRA	QTY	N.W	G.W	C.B.M	SIZE
Packing	1	7.35kg	8.95kg	0.073	840x100x880mm
 10.098	Total Size Counter: 810x440x2075mm				



EXTERNAL SIZE	ARTWORK	*mm

SALMORAL



white colored

INFORMATION

- This counter comes with carry bag and exhibitors can quickly assemble it in less than 5 minutes (no tools required). Once it has been assembled, the counter is lightweight enough to be moved with ease by one person. It has 1 plastic shelf in the interior of the display, so the extra brochures, business cards and flyers can be stored out of sight so your exhibition always appears clean and organized. This counter has a header of 1000x255mm for displaying company logos or graphs. Each counter that comes with a header is excellent for tradeshows and promotional events at stores or business presentations.

SALMORAL	QTY	N.W	G.W	C.B.M	SIZE
Packing	1	6.8kg	8.25kg	0.051	560x70x1300mm
10.043	Total Size Counter: 875x438x1915mm				

EXTERNAL SIZE	ARTWORK	*mm

BELVIS



semicircular design

INFORMATION

- This counter comes with carry bag and exhibitors can quickly assemble it in a few minutes (without tools). Once it has been assembled, the counter is lightweight enough to be moved with ease by one person. It has 1 plastic shelf in the interior of the display, so the extra brochures, business cards and flyers can be stored. Featuring a semicircular design that allows the integration of the counter in any space for exhibition and with the advantage of being more accessible than the counters of rectangular design. This counter has a header of 770x280mm for displaying company logos or graphs. Ideal for tradeshows and promotional events at any stores or business presentations.

BELVIS	QTY	N.W	G.W	C.B.M	SIZE
Packing	1	5.8kg	7.7kg	0.09	860x120x870mm
10.719	Total Size Counter: 795x440x2075mm				

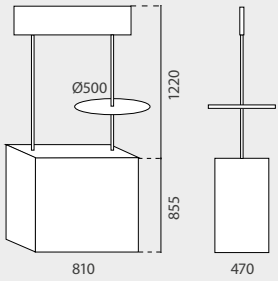
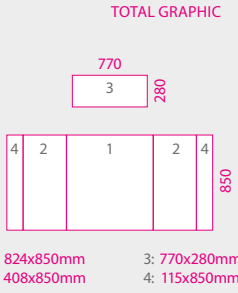
EXTERNAL SIZE	ARTWORK	*mm
		1: 824x850mm 2: 408x850mm 3: 770x280mm 4: 115x850mm

INFORMATION

- This counter comes with carry bag and exhibitors can quickly assemble it in less than 5 minutes (no tools required). Once it has been assembled, the counter is lightweight enough to be moved with ease by one person. It has 1 circular Ø500mm shelf for one pole and 1 plastic shelf in the interior of the display, so the extra brochures, business cards and flyers can be stored out and organized. This counter has a header of 770x280mm for displaying company logos or graphs. Each counter that comes with a header is excellent for tradeshows and promotional events at stores or business presentations.

MANCHESTER	QTY	N.W	G.W	C.B.M	SIZE
Packing	1	9.5kg	10.5kg	0.08	860x110x880mm
 10.676	Total Size Counter: 810x470x2075mm				

MANCHESTER

with Ø 500mm circular shelf

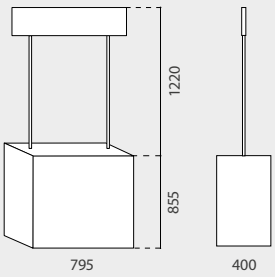
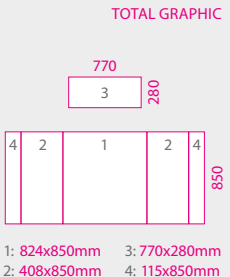

EXTERNAL SIZE	ARTWORK	*mm
		1: 824x850mm 2: 408x850mm 3: 770x280mm 4: 115x850mm

INFORMATION

- This counter comes with carry bag and exhibitors can quickly assemble it in less than 5 minutes (no tools required). Once it has been assembled, the counter is lightweight enough to be moved with ease by one person. It has 1 plastic shelf in the interior of the display, so the extra brochures, business cards and flyers can be stored and organized. Featuring a sleek blacklened look design, allowing the display to stand out against any background. The tradeshow booth has a generous amount of countertop space for several promotional items to be displayed. With a displaying header of 770x280mm, Lake Counter is excellent for tradeshows, stores or business presentations.

LAKE	QTY	N.W	G.W	C.B.M	SIZE
Packing	1	8.5kg	9.5kg	0.08	860x110x880mm
 10.675	Total Size Counter: 795x400x2075mm				

LAKE

black colored



SIGÜENZA

ARTWORK *mm

TOTAL GRAPHIC

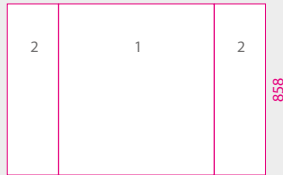
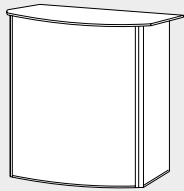

1: 1004x858mm
2: 322x858mm

INFORMATION

- This Sigüenza Counter comes with two internal shelves to give the promo stands support and provide storage space, also features 2 lockable doors so your exhibition always appears clean and organized. The aluminum frame gives the promotional counters support and makes them more stable than typical "all plastic" counters. The top counter shelf has a wooden finish for a durable, yet attractive display. The portable unit assembles quickly and disassembles into a carrying bag for an easy transport to different exhibitions.



SIGÜENZA	QTY	N.W	G.W	C.B.M	SIZE
Packing	1	27kg	30kg	0.23	950x200x1250mm

 10.493

ARTWORK *mm

TOTAL GRAPHIC

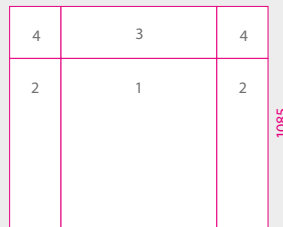
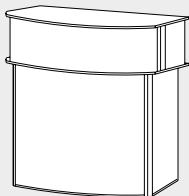

1: 1004x858mm
2: 322x858mm
3: 1122x227mm
4: 212x227mm

INFORMATION

- This Sepulveda Counter comes with 3 shelves (2 internal) to give the promo stands support and provide storage space, with third shelf the counter has an added desk where to store the utensils and reserves the surface of the counter as a free and organized reception. Also features 2 lockable doors so your exhibition always appears clean and organized. The aluminum frame gives the promotional counters support and makes them more stable than typical "all plastic" counters. The top counter shelf has a wooden finish for a durable, yet attractive display. The portable unit assembles quickly and disassembles into a carrying bag for an easy transport to different exhibitions.

SEPULVEDA



SEPULVEDA	QTY	N.W	G.W	C.B.M	SIZE
Packing	1	36.8kg	41.9kg	0.18	940x160x1190mm

 10.494



AJALVIR

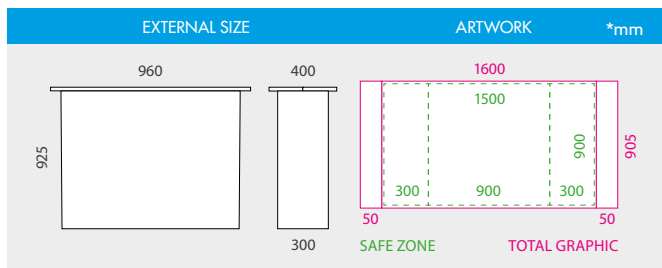

INFORMATION

- With carry bag. Very fast assembly thanks its "magic tape" system (no tools required).
- Lightweight and portable. Featuring 2 blackened wooden shelves (foldable top).
- Ideal for tradeshows, promotional events at stores or business presentations.

AJALVIR	QTY	N.W	G.W	C.B.M	SIZE
Packing	1	8.35kg	9.15kg	0.0609	290x210x1000mm
	10.323	Graphic Size: 905x1600mm			



VILLARES

with shelf inside 

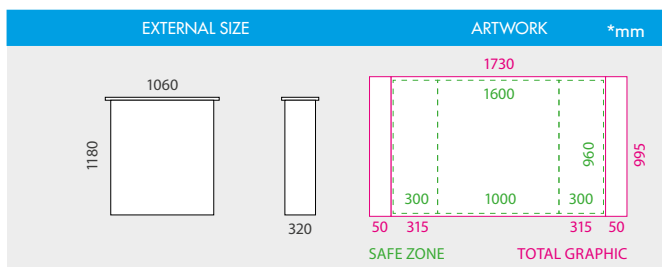

INFORMATION

- With carry bag. Very fast assembly thanks its "magic tape" system (no tools required).
- Very lightweight and portable. Featuring 2 shelves (with blackened wooden top).
- Ideal for tradeshows, promotional events at stores or business presentations.

VILLARES	QTY	N.W	G.W	C.B.M	SIZE
Bottom	1	3.1kg	6.85kg	0.12	445x230x1130mm
Top	1	5.45kg	6.6kg	0.04	465x70x1120mm
	10.096	Graphic Size: 1730x995mm			





CEZURES



EXTERNAL SIZE

ARTWORK

*mm

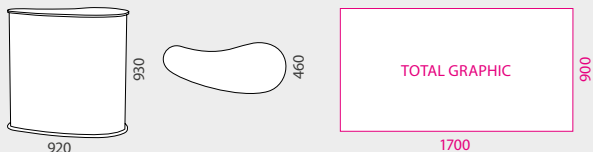

INFORMATION

- Black wood countertop and base. Fabric carrying bag with handles are included.
- This Cezures promotion counter can be used to hold promotional materials, also known as a portable stand, can be used to conduct a product demonstration. Easy to setup and breakdown, making it perfect for traveling businesspersons.

carry bag is included



CEZURES	QTY	N.W	G.W	C.B.M	SIZE
Packing	2	7.7kg	12kg	0.02	570x380x940mm

 10.686 Graphic Size: 1700x900mm



easy and fast to assemble!

ATENAS

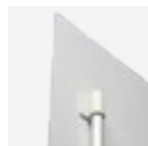

with upper header

EXTERNAL SIZE

ARTWORK

*mm

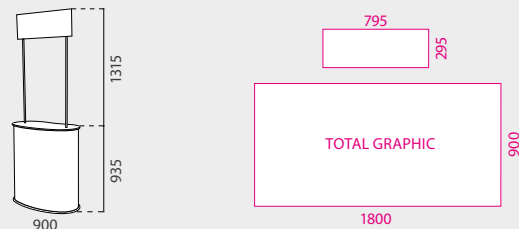

INFORMATION

- Black wood countertop and base. Fabric carrying bag with handles are included.
- It has 1 plastic shelf in the interior of the display, so your exhibition always appears clean and organized. The Atenas counter can be used to conduct a product demonstration. This Counter is easy to set-up and breakdown, making it perfect for traveling business people.. Featuring a header of 795x295mm for displaying so is ideal for tradeshow, media events or business presentations.



ATENAS	QTY	N.W	G.W	C.B.M	SIZE
Packing	1	25.8kg	27kg	0.21	500x440x940mm

 10.312 Graphic Size: 1800x900mm





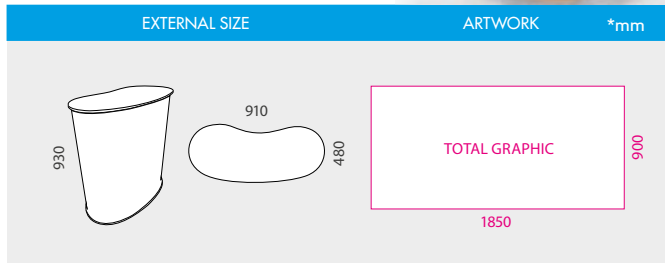

DOIRAS

black or wooden color top shelf available



INFORMATION

- Black or wooden color top shelf. Fabric carrying bag with handles are included.
- It has 1 shelf in the interior of the display, so your exhibition always appears clean and organized. This counter is ideal for a product demonstration. Also is easy to set-up and breakdown, making it perfect for traveling business people.

DOIRAS	QTY	N.W	G.W	C.B.M	SIZE
Packing	2	12kg	13kg	0.0372	500x80x930mm
		1.5kg	2kg	0.0372	200x200x930mm
 13.475		Graphic Size: 1850x900mm			
 13.476					



carry bags included



quick and simple to set up and pack

VALDES

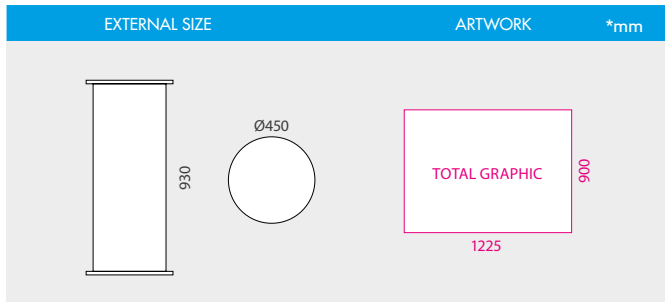

INFORMATION

- Black wood countertop and base. Fabric carrying bag with handles are included.
- The Valdes promotion counter can be used to hold promotional materials, ideal for conducting a product demonstration. Featuring a circular design that allows the integration of the counter in any space for exhibition and with the advantage of being more accessible than other counters. Fast and easy to setup.

VALDES	QTY	N.W	G.W	C.B.M	SIZE
Packing	2	3.8kg	4.3kg	0.016	460x80x460mm
		2.7kg	3.2kg	0.037	200x200x930mm
 10.685	Graphic Size: 1225x900mm				

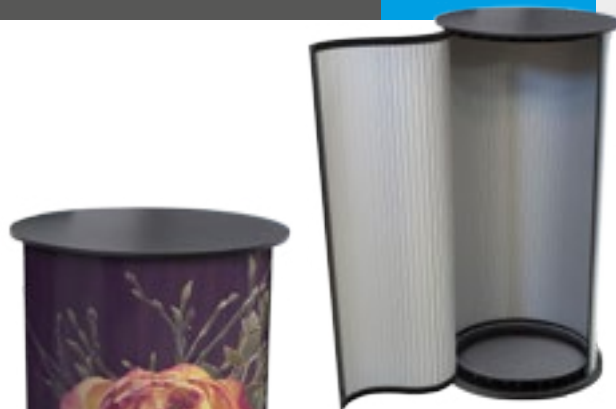

carry bag is included

CEBREROS



magnetic pop up counter with wooden shelf



INFORMATION

EXTERNAL SIZE

ARTWORK

*mm

- This stylish Promotion Counter is completely portable, functional and has 1 shelf in the interior of the display, so your exhibition always appears clean and organized. Also, There are 3 wooden finishes for the top, black, brown or yellow colored. The curved counter is lightweight and includes two carrying cases for an easy portability between events. Replacement graphics for this wooden-top trade show booth are really easy to attach to the display thanks its magnetic system. Cebreros counter is ideal for various promotional needs are often used to hold product samples, corporate literature, business cards, brochures and more so counter is perfect for a wide variety of promotional applications, including in-store displays, such as grocery 'free sample' promotions.

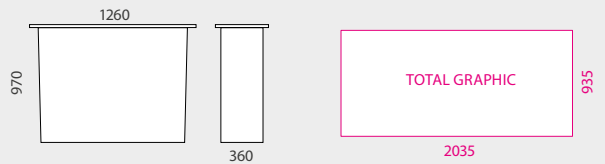

C.1	QTY	N.W	G.W	C.B.M	SIZE		
Bottom	1	7.55kg	9.55kg	0.06	380x160x1030mm		
Top	1	6.7kg	8.35kg	0.04	460x110x750mm		
	10.241		Graphic Size: 2035x935mm				

C.2	QTY	N.W	G.W	C.B.M	SIZE		
Bottom	1	7.55kg	9.55kg	0.06	380x160x1030mm		
Top	1	6.7kg	8.35kg	0.04	460x110x750mm		
	10.392		Graphic Size: 2035x935mm				

C.3	QTY	N.W	G.W	C.B.M	SIZE		
Bottom	1	7.55kg	9.55kg	0.06	380x160x1030mm		
Top	1	6.7kg	8.35kg	0.04	460x110x750mm		
	10.042		Graphic Size: 2035x935mm				

PROMOTION COUNTERS | Tension Fabric Counters

EN Counters for textile printing. Aluminium structure.

FR Comptoir pour toile tendue. Structure en aluminium.

PT Balcão para colocação de tecido. Estrutura em alumínio.

ES Mostradores Tension Fabric para textil. Estructura de aluminio.



*Printed on fabric.
Impression sur toile.
Impressão em tecido.
Impresión en tela.

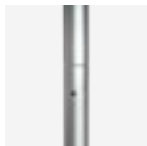

BARACOA



carry bag included



INFORMATION

These Counters are designed for using with fabric wrap (printed on textile) making it lightweight and easy to fold. Also, the Fabric Counters are also simple to setup. All the aluminium poles fit together and snap into place. Simply stretch the wrap over the completed base and it's ready to use. With carry bag for easy travelling. Features a double zip to the interior of the counter for storing, so your exhibition always appears clean and organized. Baracoa is ideal as a lectern or podium at tradeshow, promotional events or conventions and are great to pair with Pop Up banners or any stand.

BARACOA	QTY	N.W	G.W	C.B.M	SIZE
Packing	1	8kg	9.2kg	0.042	860x120x410mm
✿ 13.740		Graphic Size: 2103x1030mm			

EXTERNAL SIZE

ARTWORK

*mm

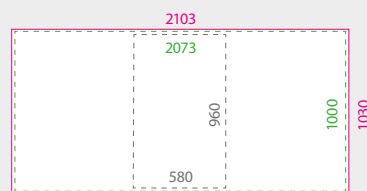
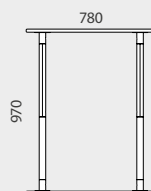

FRONT VIEW
SAFE ZONE
TOTAL GRAPHIC





3 points of view



EXTERNAL SIZE

*mm

ARTWORK

DOWNLOAD

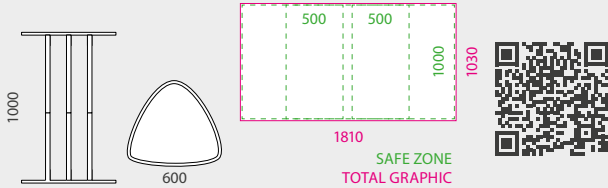

INFORMATION

Creta is lightweight and easy to fold and setup. With carry bag and a single zip to the interior for storing. Features 3 points of view, so this Counter is ideal as a lectern or podium at tradeshows, promotional events or conventions and are great to pair with Pop Up banners or any stand.

CRETA	QTY	N.W	G.W	C.B.M	SIZE
Packing	1	7kg	8.2kg	0.03721	610x100x610mm
10.311	Graphic Size: 1810x1030mm				

CRETA

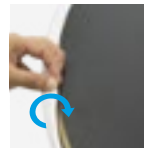

*Printed on fabric.
Impression sur toile.
Impressão em tecido.
Impresión en tela.

hard case



slightly push down



automatic hydraulic unfolding



EXTERNAL SIZE

*mm

ARTWORK

DOWNLOAD

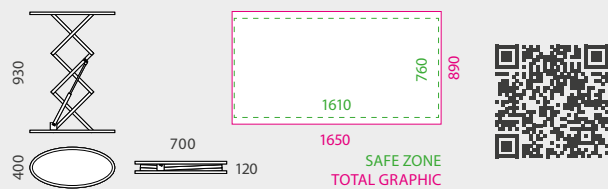

INFORMATION

Siena is lightweight and easy to fold and setup. With a hard carry padded bag and a double zip to the interior for storing. Features an **hydraulic drive system** for an automatic and quick unfolding with just a slight push on the top of the counter. Counter is ideal as a lectern or podium at tradeshows, promotional events or conventions and are great to pair with Pop Up banners or any stand.

SIENA	QTY	N.W	G.W	C.B.M	SIZE
Packing	1	5.6kg	7.6kg	0.21	970x600x360mm
15.244	Graphic Size: 890x1650mm				

SIENA

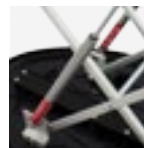

*Printed on fabric.
Impression sur toile.
Impressão em tecido.
Impresión en tela.



oval shape



EXTERNAL SIZE *mm ARTWORK DOWNLOAD

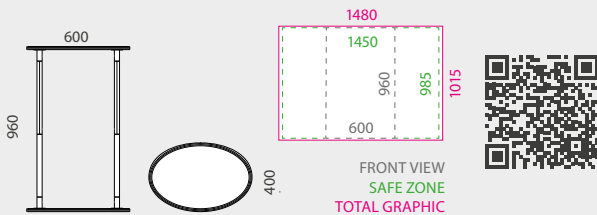

INFORMATION

Manacor is lightweight and fast to setup. Features an oval shape design that allows the advantage of being more accessible than others. With carry bag and a double zip to the interior for storing. Ideal as a lectern or podium at tradeshows, promotional events or great to pair with Pop Ups or any stand.

MANACOR	QTY	N.W	G.W	C.B.M	SIZE
Packing	1	7.0kg	7.44kg	0.0366	440x130x640mm
10.318	Graphic Size: 1480x1015mm				

MANACOR

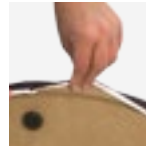

*Printed on fabric.
Impression sur toile.
Impressão em tecido.
Impresión en tela.

raindrop shape



EXTERNAL SIZE *mm ARTWORK DOWNLOAD

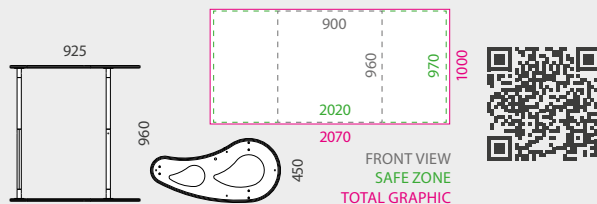

INFORMATION

Mahon is lightweight and easy to assembly. Features the classic raindrop shape design. With carry bag and a double zip to the interior for storing. Mahon is a counter widely used at promotional events, tradeshows, point of sales, so is ideal as a lectern or podium or great to pair with Pop Ups or any stand.

MAHON	QTY	N.W	G.W	C.B.M	SIZE
Packing	1	10.50kg	10.93kg	0.0672	500x140x960mm
10.319	Graphic Size: 2070x1000mm				

MAHON



*Printed on fabric.
Impression sur toile.
Impressão em tecido.
Impresión en tela.

POSTER SYSTEM | Poster System

EN Poster System for graphical support through suspension. Easy and fast change of graphic. Kits contain profile bar and hangers.



FR Barre à clips pour suspension de visuel. Permet le changement rapide et simple des visuels. Kit complet (profil et anneaux).













PT Sistema aéreo onde se pode suspender imagens. Mudança de imagem rápida e fácil. Cada kit inclui perfil e ganchos de suspensão.

ES Sistema de soporte para gráfica mediante suspensión de un perfil. Cambio de gráficas rápido y sencillo. Contiene perfiles y colgadores.

INFORMATION *mm

- 3 sizes available of profile.
- Three colors available: white, transparent and black. Each Kit contains profile and hangers.



CHEAPCLIP 500	QTY	N.W	G.W	C.B.M	SIZE
Packing	12	0.16kg	0.36kg	0.014	360x80x520mm
 10.621	<input type="checkbox"/>	500mm		x12	
 10.622	<input type="checkbox"/>				
 10.623	<input type="checkbox"/>				
CHEAPCLIP 800	QTY	N.W	G.W	C.B.M	SIZE
Packing	12	0.28kg	0.48kg	0.023	360x80x820mm
 10.624	<input type="checkbox"/>	800mm		x12	
 10.625	<input type="checkbox"/>				
 10.626	<input type="checkbox"/>				
CHEAPCLIP 1000	QTY	N.W	G.W	C.B.M	SIZE
Packing	12	0.36kg	0.56kg	0.029	360x80x1020mm
 10.627	<input type="checkbox"/>	1000mm		x12	
 10.628	<input type="checkbox"/>				
 10.629	<input type="checkbox"/>				













CHEAPCLIP



INFORMATION *mm

- 3 sizes available of profile.
- Three colors available: white, transparent and black. Each Kit contains profile and hangers.

SOFTCLIP 500	QTY	N.W	G.W	C.B.M	SIZE
Packing	12	0.28kg	0.4kg	0.014	360x80x520mm
 10.612	<input type="checkbox"/>	500mm		x12	
 10.613	<input type="checkbox"/>				
 10.614	<input type="checkbox"/>				
SOFTCLIP 800	QTY	N.W	G.W	C.B.M	SIZE
Packing	12	0.52kg	0.72kg	0.023	360x80x820mm
 10.615	<input type="checkbox"/>	800mm		x12	
 10.616	<input type="checkbox"/>				
 10.617	<input type="checkbox"/>				
SOFTCLIP 1000	QTY	N.W	G.W	C.B.M	SIZE
Packing	12	0.72kg	0.91kg	0.029	360x80x1020mm
 10.618	<input type="checkbox"/>	1000mm		x12	
 10.619	<input type="checkbox"/>				
 10.620	<input type="checkbox"/>				

SOFTCLIP



INFORMATION

*mm

- 3 sizes available of profile.
- 3 colors available: white, transparent and black. Each Kit contains profile and hangers.



BESTCLIP 500	QTY	N.W	G.W	C.B.M	SIZE
Packing	12	0.4kg	0.6kg	0.014	360x80x520mm
 10.603	<input type="checkbox"/>	500mm		x12	
 10.604	<input type="checkbox"/>				
 10.605	<input type="checkbox"/>				

BESTCLIP 800	QTY	N.W	G.W	C.B.M	SIZE
Packing	12	0.64kg	0.84kg	0.023	360x80x820mm
 10.606	<input type="checkbox"/>	800mm		x12	
 10.607	<input type="checkbox"/>				
 10.608	<input type="checkbox"/>				

BESTCLIP 1000	QTY	N.W	G.W	C.B.M	SIZE
Packing	12	0.72kg	0.92kg	0.029	360x80x1020mm
 10.609	<input type="checkbox"/>	1000mm		x12	
 10.610	<input type="checkbox"/>				
 10.611	<input type="checkbox"/>				

BESTCLIP









INFORMATION



*mm



- 3 sizes available of profile.
- 3 colors available: white, transparent and black. Each Kit contains profile and hangers.





PLASTICLIP 440	QTY	N.W	G.W	C.B.M	SIZE
Packing	12	0.48kg	0.68kg	0.004	130x90x440mm
 10.526	<input type="checkbox"/>	440mm		x12	
 10.527	<input type="checkbox"/>				

PLASTICLIP 500	QTY	N.W	G.W	C.B.M	SIZE
Packing	12	0.6kg	0.8kg	0.005	130x90x500mm
 10.528	<input type="checkbox"/>	500mm		x12	
 10.529	<input type="checkbox"/>				

PLASTICLIP 600	QTY	N.W	G.W	C.B.M	SIZE
Packing	12	0.72kg	0.92kg	0.007	360x90x600mm
 10.530	<input type="checkbox"/>	600mm		x12	
 10.531	<input type="checkbox"/>				

PLASTICLIP 800	QTY	N.W	G.W	C.B.M	SIZE
Packing	12	0.88kg	1.05kg	0.009	130x90x800mm
 10.532	<input type="checkbox"/>	800mm		x12	
 10.533	<input type="checkbox"/>				

PLASTICLIP 1000	QTY	N.W	G.W	C.B.M	SIZE
Packing	12	1.08kg	1.2kg	0.01	130x90x1000mm
 10.534	<input type="checkbox"/>	1000mm		x12	
 10.535	<input type="checkbox"/>				

PLASTICLIP























INFORMATION

*mm

- 3 sizes available of profile.
- 3 colors available: white, transparent and black. Each Kit includes profile, cap and hangers.



STRONGCLIP 500	QTY	N.W	G.W	C.B.M	SIZE
Packing	12	0.52kg	0.72kg	0.029	360x160x520mm
 10.630		500mm		x12	
 10.631					
 10.632					
STRONGCLIP 800	QTY	N.W	G.W	C.B.M	SIZE
Packing	12	1kg	1.2kg	0.035	270x160x820mm
 10.633		800mm		x12	
 10.634					
 10.635					
STRONGCLIP 1000	QTY	N.W	G.W	C.B.M	SIZE
Packing	12	1.2kg	1.4kg	0.044	270x160x1020mm
 10.636		1000mm		x12	
 10.637					
 10.638					

STRONGCLIP



INFORMATION

*mm

- 4 sizes available of profile.
- Each Kit contains endcaps, profile, gripper and hangers.

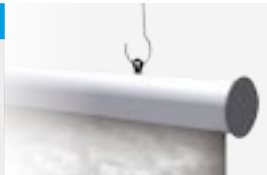

ALUGRIP 300	QTY	N.W	G.W	C.B.M	SIZE
Packing	4	0.31kg	0.5kg	0.0008	50x45x340mm
 10.172		300mm		x4	
ALUGRIP 500	QTY	N.W	G.W	C.B.M	SIZE
Packing	4	0.51kg	0.7kg	0.0012	50x45x540mm
 10.173		500mm		x4	
ALUGRIP 700	QTY	N.W	G.W	C.B.M	SIZE
Packing	4	0.7kg	0.85kg	0.0017	50x45x740mm
 10.174		700mm		x4	
ALUGRIP 1000	QTY	N.W	G.W	C.B.M	SIZE
Packing	4	1kg	1.4kg	0.0023	50x45x1040mm
 10.175		1000mm		x4	

ALUGRIP





with grippers for holding graphics

ALUGRIP ACCESSORIES

ALUGRIP GRIPPERS

- 10 grippers for Alugrip Profile. Ideal for holding graphics.





ALU GRIPPER	QTY	N.W	G.W	C.B.M	SIZE
Packing	10	0.025kg	0.03kg	0.0005	75x75x90mm
 10.176		50mm		x10	

ALUGRIP ENDCAPS

- 10 endcaps for Alugrip Profile. For completing profiles.





ALU ENDCAPS	QTY	N.W	G.W	C.B.M	SIZE
Packing	10	0.007kg	0.008kg	0.0005	75x75x90mm
 10.177				x10	

ALUGRIP HANGERS

- 10 hangers for Alugrip Profile. For suspending profiles.





ALU HANGERS	QTY	N.W	G.W	C.B.M	SIZE
Packing	10	0.005kg	0.005kg	0.0005	75x75x90mm
 10.178				x10	

ALUGRIP HANGERS

- 10 hangers for Alugrip Profile. For suspending profiles.



ALU HANGERS	QTY	N.W	G.W	C.B.M	SIZE
Packing	10	0.006kg	0.01kg	0.00004	65x10x65mm
 10.179				x10	

INFORMATION



*mm



- 6 sizes available of profile.
- Each Kit contains profile, 2 endcaps and 2 hangers.



ALUPOSTER



ALU P.300	QTY	N.W	G.W	C.B.M	SIZE
Packing	4	0.4kg	0.6kg	0.0014	80x60x310mm
*10.086	300mm	x4			
ALU P.500	QTY	N.W	G.W	C.B.M	SIZE
Packing	4	0.72kg	0.92kg	0.0024	80x60x510mm
*10.087	500mm	x4			
ALU P.800	QTY	N.W	G.W	C.B.M	SIZE
Packing	4	1.12kg	1.32kg	0.0038	80x60x810mm
*10.088	800mm	x4			

ALU P.1000	QTY	N.W	G.W	C.B.M	SIZE
Packing	4	1.48kg	1.68kg	0.0048	80x60x1010mm
*10.089	1000mm	x4			
ALU P.1200	QTY	N.W	G.W	C.B.M	SIZE
Packing	4	1.68kg	1.88kg	0.0058	80x60x1210mm
*10.090	1200mm	x4			
ALU P.1500	QTY	N.W	G.W	C.B.M	SIZE
Packing	4	2kg	2.2kg	0.0072	80x60x1510mm
*10.091	1500mm	x4			

ALUPOSTER ACCESSORIES

ALUPOSTER ENDCAPS

*mm

- 10 endcaps for completing Aluposter profiles.



P. ENDCAP	QTY	N.W	G.W	C.B.M	SIZE
Packing	1	0.009kg	0.02kg	0.00004	65x10x65mm
*13.399			x10		

RING CLIP

*mm

- 10 endcaps for completing Aluposter profiles.



RING CLIP	QTY	N.W	G.W	C.B.M	SIZE
Packing	1	0.047kg	0.01kg	0.00004	65x10x65mm
*13.400			x10		

INFORMATION



*mm



- 6 sizes available of profile. Each Kit contains: 1 Aluclip profile, 2 endcaps and 2 hangers.

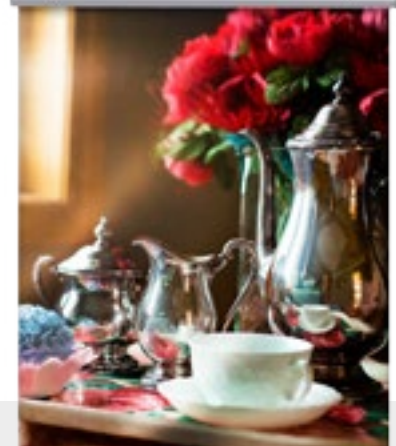

ALUCLIP



ALUCLIP 300	QTY	N.W	G.W	C.B.M	SIZE
Packing	4	0.35kg	0.5kg	0.0009	65x40x320mm
*10.080	300mm	x4			
ALUCLIP 500	QTY	N.W	G.W	C.B.M	SIZE
Packing	4	0.57kg	0.8kg	0.0014	65x40x540mm
*10.081	500mm	x4			
ALUCLIP 800	QTY	N.W	G.W	C.B.M	SIZE
Packing	4	0.9kg	1.2kg	0.0022	65x40x840mm
*10.082	800mm	x4			

ALUCLIP 1000	QTY	N.W	G.W	C.B.M	SIZE
Packing	4	1.2kg	1.5kg	0.0027	65x40x1040mm
*10.083	1000mm	x4			
ALUCLIP 1200	QTY	N.W	G.W	C.B.M	SIZE
Packing	4	1.4kg	1.8kg	0.0032	65x40x1240mm
*10.084	1200mm	x4			
ALUCLIP 1500	QTY	N.W	G.W	C.B.M	SIZE
Packing	4	1.7kg	2.2kg	0.004	65x40x1540mm
*10.085	1500mm	x4			

ALUCLIP ACCESSORIES

ALUCLIP ENDCAPS

*mm

- 10 endcaps for completing Aluclip profiles.



P. ENDCAP	QTY	N.W	G.W	C.B.M	SIZE
Packing	1	0.009kg	0.02kg	0.00004	65x10x65mm
*13.398			x10		

RING CLIPS

*mm

- 10 endcaps for completing Aluposter profiles.



RING CLIP	QTY	N.W	G.W	C.B.M	SIZE
Packing	1	0.047kg	0.01kg	0.00004	65x10x65mm
*13.400			x10		

INFORMATION

*mm

- 6 sizes available of profile. Kit contains:
1 Alulon profile, 2 endcaps and 2 hangers.



ALULON



ALULON 500	QTY	N.W	G.W	C.B.M	SIZE
------------	-----	-----	-----	-------	------

Packing	4	1.2kg	1.4kg	0.0017	540x90x35mm
---------	---	-------	-------	--------	-------------

 10.571	500mm	x4			
--	-------	----	---	--	--

ALULON 800	QTY	N.W	G.W	C.B.M	SIZE
------------	-----	-----	-----	-------	------

Packing	4	1.8kg	2.1kg	0.0026	90x35x840mm
---------	---	-------	-------	--------	-------------

 10.191	800mm	x4			
--	-------	----	---	--	--

ALULON 1000	QTY	N.W	G.W	C.B.M	SIZE
-------------	-----	-----	-----	-------	------

Packing	4	2.2kg	2.6kg	0.0033	90x35x1040mm
---------	---	-------	-------	--------	--------------

 10.572	1000mm	x4			
--	--------	----	---	--	--

ALULON 1200	QTY	N.W	G.W	C.B.M	SIZE
-------------	-----	-----	-----	-------	------

Packing	4	2.7kg	3kg	0.0039	90x35x1240mm
---------	---	-------	-----	--------	--------------

 10.193	1200mm	x4			
--	--------	----	---	--	--

ALULON 1500	QTY	N.W	G.W	C.B.M	SIZE
-------------	-----	-----	-----	-------	------

Packing	4	3.4kg	3.8kg	0.0049	90x35x1540mm
---------	---	-------	-------	--------	--------------

 10.194	1500mm	x4			
--	--------	----	---	--	--

ALULON 3000	QTY	N.W	G.W	C.B.M	SIZE
-------------	-----	-----	-----	-------	------

Packing	4	6.5kg	7.4kg	0.0123	90x45x3025mm
---------	---	-------	-------	--------	--------------

 10.195	3000mm	x4			
--	--------	----	---	--	--

ALULON ACCESSORIES

ALULON ENDCAPS



*mm

- 10 endcaps for completing Alulon profiles.



ENDCAP	QTY	N.W	G.W	C.B.M	SIZE
--------	-----	-----	-----	-------	------

Packing	1	0.009kg	0.02kg	0.00004	65x10x65mm
---------	---	---------	--------	---------	------------

 10.196			x10		
--	--	--	-----	---	--

RING CLIPS



*mm

- 10 hangers for completing Alulon profiles.



H.RING CLIP	QTY	N.W	G.W	C.B.M	SIZE
-------------	-----	-----	-----	-------	------

Packing	1	0.047kg	0.01kg	0.00004	65x10x65mm
---------	---	---------	--------	---------	------------

 10.197			x10		
--	--	--	-----	--	--

INFORMATION

*mm

- 10 endcaps for completing profiles.



FASTCLIP



FASTCLIP 300	QTY	N.W	G.W	C.B.M	SIZE
--------------	-----	-----	-----	-------	------

Packing	4	0.65kg	0.8kg	0.0018	340x90x60mm
---------	---	--------	-------	--------	-------------

 50.600	300mm	x4			
--	-------	----	---	--	--

FASTCLIP 500	QTY	N.W	G.W	C.B.M	SIZE
--------------	-----	-----	-----	-------	------

Packing	4	1.17kg	1.4kg	0.0029	540x90x60mm
---------	---	--------	-------	--------	-------------

 50.601	500mm	x4			
--	-------	----	---	--	--

FASTCLIP 800	QTY	N.W	G.W	C.B.M	SIZE
--------------	-----	-----	-----	-------	------

Packing	4	1.7kg	2kg	0.0045	840x90x60mm
---------	---	-------	-----	--------	-------------

 50.602	800mm	x4			
--	-------	----	---	--	--

FASTCLIP 1000	QTY	N.W	G.W	C.B.M	SIZE
---------------	-----	-----	-----	-------	------

Packing	4	2kg	2.45kg	0.0056	90x60x1040mm
---------	---	-----	--------	--------	--------------

 50.603	1000mm	x4			
--	--------	----	---	--	--

FASTCLIP 1200	QTY	N.W	G.W	C.B.M	SIZE
---------------	-----	-----	-----	-------	------

Packing	4	2.4kg	2.9kg	0.0067	90x60x1240mm
---------	---	-------	-------	--------	--------------

 50.604	1200mm	x4			
--	--------	----	---	--	--

FASTCLIP 1500	QTY	N.W	G.W	C.B.M	SIZE
---------------	-----	-----	-----	-------	------

Packing	4	2.9kg	3.5kg	0.0083	90x60x1540mm
---------	---	-------	-------	--------	--------------

 50.605	1500mm	x4			
--	--------	----	---	--	--

INFORMATION

*mm

- 10 endcaps for completing profiles.



SEMI CIRCULAR FASTCLIP



SEMI C.F.300	QTY	N.W	G.W	C.B.M	SIZE
--------------	-----	-----	-----	-------	------

Packing	4	0.45kg	0.6kg	0.0015	340x100x45mm
---------	---	--------	-------	--------	--------------

 50.606	300mm	x4			
--	-------	----	---	--	--

SEMI C.F.500	QTY	N.W	G.W	C.B.M	SIZE
--------------	-----	-----	-----	-------	------

Packing	4	0.7kg	1kg	0.0024	100x45x540mm
---------	---	-------	-----	--------	--------------

 50.607	500mm	x4			
--	-------	----	---	--	--

SEMI C.F.800	QTY	N.W	G.W	C.B.M	SIZE
--------------	-----	-----	-----	-------	------

Packing	4	1kg	1.4kg	0.0038	100x45x840mm
---------	---	-----	-------	--------	--------------

 50.608	800mm	x4			
--	-------	----	---	--	--

SEMI C.F.1000	QTY	N.W	G.W	C.B.M	SIZE
---------------	-----	-----	-----	-------	------

Packing	4	1.3kg	1.8kg	0.0047	100x45x1040mm
---------	---	-------	-------	--------	---------------

 50.609	1000mm	x4			
--	--------	----	---	--	--

SEMI C.F.1200	QTY	N.W	G.W	C.B.M	SIZE
---------------	-----	-----	-----	-------	------

Packing	4	1.5kg	2.1kg	0.0056	100x45x1250mm
---------	---	-------	-------	--------	---------------

 50.610	1200mm	x4			
--	--------	----	---	--	--

SEMI C.F.1500	QTY	N.W	G.W	C.B.M	SIZE
---------------	-----	-----	-----	-------	------

Packing	4	1.95kg	2.5kg	0.0069	100x45x1540mm
---------	---	--------	-------	--------	---------------

 50.611	1500mm	x4			
--	--------	----	---	--	--

DECORAIL

EN The decorail is a profile system composed by an aluminium bar in which they can anchor multiple advertising systems. Ideal for islands and supermarket modules.

FR Système portable pour publicité qui comprend un profil en aluminium afin d'y insérer multiples systèmes publicitaires. Idéal pour les supermarchés.

PT Decorail é um sistema aéreo composto por um perfil de alumínio, onde se pode suspender sistemas publicitários. Ideal para ilhas ou módulos de supermercado.

ES Sistema de perfil aéreo compuesto por perfiles de aluminio en los que anclar múltiples elementos publicitarios. Ideal para islas y módulos de supermercados.



INFORMATION

*mm

Features a 47 mm high aluminium profile. Deco Rail offers the optional opportunity to customize the inside front of the rail with a graphic. Ideal for overhead labelling. Ideal for promoting offers, products as priceholders, suspending promotions on products, increasing their visibility in supermarket sections



DECORAIL ALUMINIUM PROFILE



easy and fast set up!

optional inside front graphic

fast-simple graphic change

DECO AL.	QTY	N.W	G.W	C.B.M	SIZE
Packing	4	6.5kg	7.4kg	0.0123	90x45x3025mm

50.620 3000mm x4 

DECORAIL ENDCAP



INFORMATION

*mm

Pack of 10 gray plastic endcaps for completing the Decorail profile.

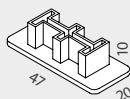

DECO ENDCAP	QTY	N.W	G.W	C.B.M	SIZE
Packing	1	0.009kg	0.02kg	0.0004	65x10x65mm

50.622 x10 

DECORAIL HANGER RING CLIP

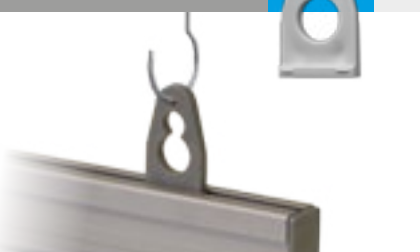

INFORMATION

*mm

Pack of 10 plastic hanger Ring Clip for suspending the Decorail profile.

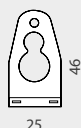

H.R.CLIP	QTY	N.W	G.W	C.B.M	SIZE
Packing	10	0.047kg	0.01kg	0.00004	65x10x65mm

10.197 x10 

DECORAIL CLIP HANGER

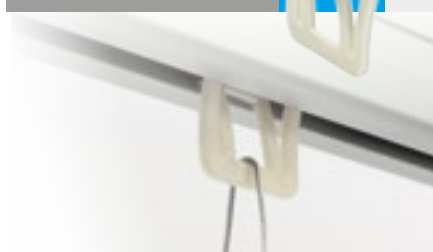

INFORMATION

*mm

Pack of 10 plastic Clip Hanger for suspending promotional graphics.

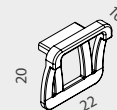

DECO CLIP	QTY	N.W	G.W	C.B.M	SIZE
Packing	1	0.009kg	0.02kg	0.0004	65x10x65mm

50.623 x10 

DISPENSER DISPLAYS | Dispenser Units



EN Dispensers made of different materials for the exhibition and sale of promotional items.

FR Présentoir fabriqué en différents types de matériaux pour vente et l'exposition de produits.

PT Expositor fabricado em diferentes materiais, para a venda e exibição de produtos.

ES Expositores realizados en diferentes materiales para la exposición y venta de artículos.



with front dispenser

TABLE DISPLAY

INFORMATION

*mm

This multipurpose table merchandiser features 1 front dispenser and is very easy and fast to assemble. It allows you to customize the presentation with your own graphics. Perfect as eye-catching point of purchase presentation on any counter to display the last minute add-on items, for customers to purchase as they are checking out.

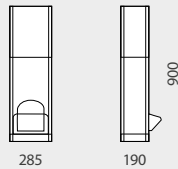

TABLE DISPLAY	QTY	N.W	G.W	C.B.M	SIZE
Packing	1	2.5kg	3.6kg	0.058	300x210x920mm
10.475	Total Display Size: 285x190x900mm				



WALL DISPLAY



INFORMATION

*mm

This stand merchandiser features 1 front dispenser and is easy to set-up. It allows to customize it with your own graphics. Perfect as eye-catching point of purchase presentation at any mall or shop.

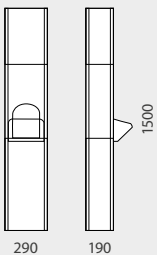

WALL DISPLAY	QTY	N.W	G.W	C.B.M	SIZE
Packing	1	3.7kg	5.46kg	0.1238	335x240x1540mm
10.476	Total Display Size: 290x190x1500mm				

FLOOR DISPLAY



INFORMATION

*mm

This stand merchandiser features 2 front dispensers and is easy to set-up. It allows to customize it with your own graphics. Perfect as eye-catching point of purchase presentation at any mall or shop.

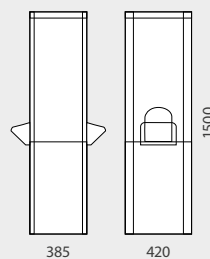

FLOOR DISPLAY	QTY	N.W	G.W	C.B.M	SIZE
Packing	1	7.35kg	8.2kg	0.27	450x400x1520mm
10.477	Total Display Size: 420x385x1500mm				

INFORMATION

*mm

This squared dumpbin is made of transparent plastic. Features 1 shelf and the possibility of placing it in two different heights, so in this way you can have two different capacities for displaying the product. Also, you can add your customized print to one or more faces of the bin to suit your own requirements. The edge of the upper perimeter is reinforced with protective cover. Promo Square is lightweight, ideal as floor standing unit for being used in your store. Place the piece near to the point of purchase locations for impulse buys on any merchandise you choose.

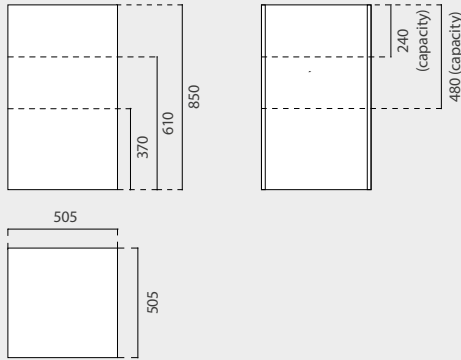

PSQUARE	QTY	N.W	G.W	C.B.M	SIZE
Packing	1	4.35kg	5.1kg	0.02	540x45x900mm
10.440	Graphic Size: 610x505mm(x4) or 370x505(x4)				

PROMO SQUARE



2 heights available
370mm or 610mm



transparent plastic

INFORMATION

*mm

This Easy Dispenser Display is made of injected plastic. Features 3 shelves and top surface of a lower module with wheels. So in this way you have 4 spaces for displaying and exhibition of the product. Also, you can add your customised print to the top header and faces of the cardboard lower module (included) to suit your own requirements. This mobile display is very easy to move inside your business, ideal as floor standing unit to use it wherever the local need is required. Place the piece near to the point of purchase locations for impulse buys on any merchandise you choose.

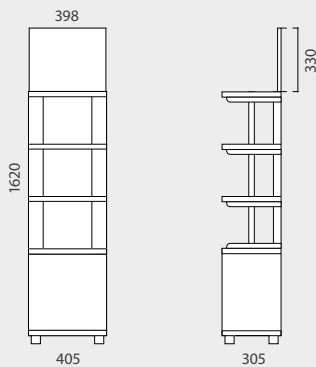

"EASY"	QTY	N.W	G.W	C.B.M	SIZE
Packing	1	4kg	4.8kg	0.0572	520x155x710mm
10.478	Total Dispenser Size: 305x405x1620mm				

"EASY"

4 spaces of exhibition



EN Display made of injected plastic, for the exhibition and implementation of products. Easy to assemble. The plastic screws and assembling pieces for the billboard can be interchangeable between the display units, depending model.

FR Présentoir en plastique injecté pour l'exposition et l'implantation de produits. Montage simple et rapide. Les vis en plastique et les pièces du support des visuels (interchangeable) sont fournies selon le modèle.

PT Expositor em plástico injectado para promoção e implantação de artigos. Montagem fácil. Inclui os parafusos e as peças de fixação necessárias para a colocação da impressão nos módulos, dependendo do modelo.

ES Expositor realizado en plástico inyectado para la exposición e implantación de productos. Montaje sencillo. Los tornillos de plástico y la sujeción de cartelería se suministran con los displays, según modelo.

ARTWORK *mm

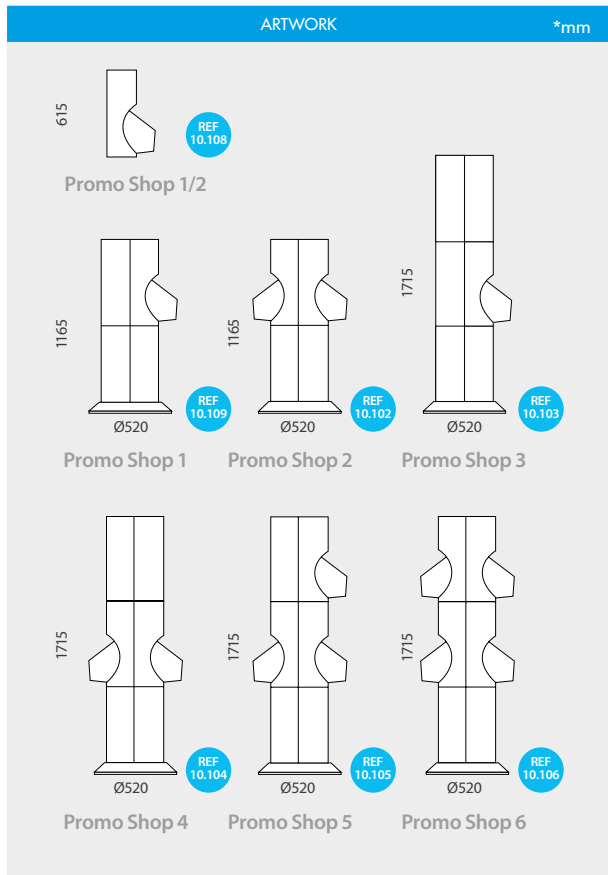

Promo Shop 1/2 REF 10.108 (Height: 615)

Promo Shop 1 REF 10.109 (Height: 1165, Diameter: Ø520)

Promo Shop 2 REF 10.102 (Height: 1165, Diameter: Ø520)

Promo Shop 3 REF 10.103 (Height: 1715, Diameter: Ø520)

Promo Shop 4 REF 10.104 (Height: 1715, Diameter: Ø520)

Promo Shop 5 REF 10.105 (Height: 1715, Diameter: Ø520)

Promo Shop 6 REF 10.106 (Height: 1715, Diameter: Ø520)

INFORMATION **ARTWORK** *mm

This merchandiser stand is made of injected plastic and features an easy configuration to set-up. It allows personalization with graphs and a personal configuration, choosing the number of dispensers that require your needs. Perfect as eye-catching point of purchase presentation at any mall or shop.

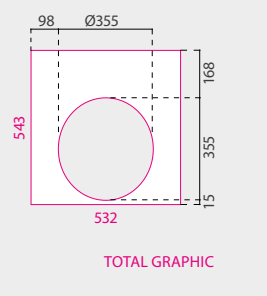

TOTAL GRAPHIC

STANDARD SIZES

PROMO SHOP	GRAPHIC SIZE
10.108	Promo Shop 1/2
10.109	Promo Shop 1
10.102	Promo Shop 2
10.103	Promo Shop 3
10.104	Promo Shop 4
10.105	Promo Shop 5
10.106	Promo Shop 6

PROMO SHOP



1 - 4 dispensers available



EN

SETUP:

- 1. Place the pieces that will hold the graphic as picture **3**.
- 2. Join the pieces of part **1** and **2** of the exhibitor.
- 3. If you want to place the vertical divider, join parts **1** and **2**, then the exhibitor is being divided into two parts.
- 4. Place the base (disk piece) on the bottom of the exhibitor.
- 5. Next, place the screws through the holes.
- 6. Place the graphic on its correspondent place.
- 7. Assemble the different modules.
- 8. Tighten the screws with the nuts.

FR

MONTAGE:

- 1. Placer les pièces de fixation du visuel sur l'image **3**.
- 2. Unir les parties **1** et **2** du présentoir.
- 3. Si vous désirez un séparateur vertical, placé-le lorsque vous unirez les parties **1** et **2**, vous obtiendrez ainsi un présentoir divisé en deux parties.
- 4. Emboîter le disque séparateur au fond du présentoir.
- 5. Mettre les vis dans chaque trou.
- 6. Placer le visuel.
- 7. Monter les différents modules.
- 8. Serrer les vis avec les écrous.

PT

MONTAGEM:

- 1. Colocar as peças de fixação na impressão de acordo com a imagem **3**.
- 2. Unir as partes **1** e **2** do expositor.
- 3. Se desejar o separador vertical, terá de colocá-lo ao unir as partes **1** e **2**, ficando o expositor dividido ao meio.
- 4. Encaixar o disco separador no fundo do expositor.
- 5. Introduzir os parafusos de forma a que atravessam todos os orifícios.
- 6. Colocar as impressões.
- 7. Montar os diferentes módulos.
- 8. Apertar os parafusos com as respectivas porcas.

ES

MONTAJE:

- 1. Colocar las piezas de sujección de cartelería, ver fotografía **3**.
- 2. Unir las partes **1** y **2** del expositor.
- 3. Si desea separador vertical colocar al unir las partes **1** y **2**, quedando entonces el expositor dividido en dos partes.
- 4. Encajar el disco separador como base en el fondo del expositor.
- 5. A continuación, colocar los tornillos, atravesando todos los agujeros.
- 6. Colocar las gráficas.
- 7. Montar los distintos módulos.
- 8. Apretar los tornillos con las tuercas.

PROMO SHOP

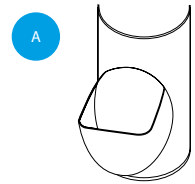
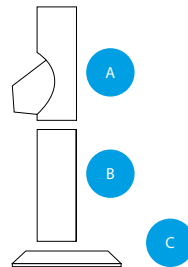
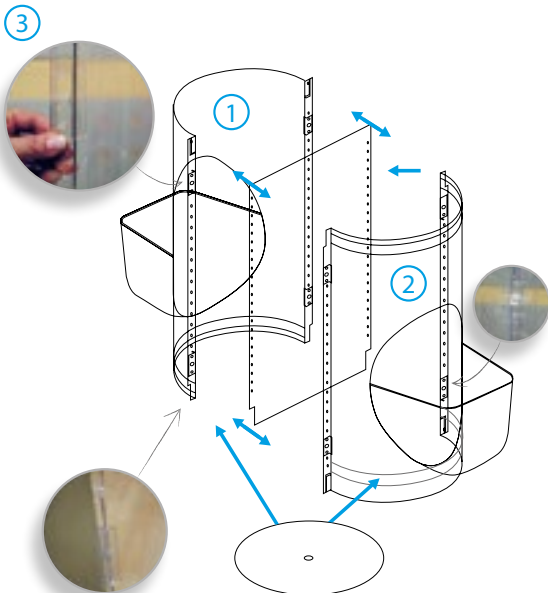

DISPENSER SECTION	QTY	N.W
Packing	1	1.1kg

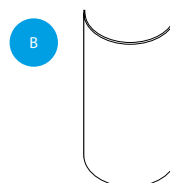

FLAT SECTION	QTY	N.W
Packing	1	1kg

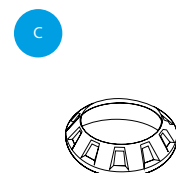

BASE SECTION	QTY	N.W
Packing	1	0.5kg

WOODEN
PROMO BOWL



lightweight
wooden
base

INFORMATION

*mm

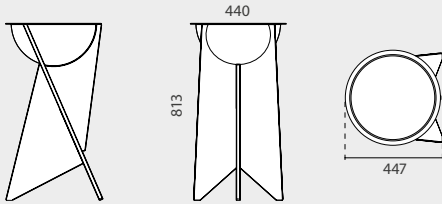

This merchandising bowl with wooden base is ideal for displaying the last minute add-on items thanks its 440mm diameter hemisphere made of transparent polycarbonate. Perfect for exhibition at playstores, malls or shops.

W.P.BOWL	QTY	N.W	G.W	C.B.M	SIZE
Semisphere	1	0.75kg	1.85kg	0.0561	492x485x235mm
Wood Base	1	4.95kg	5.75kg	0.0196	900x435x50mm
13.481	Natural Wood				

ALUMINIUM
PROMO BOWL



semisphere
allows a great
visibility of
product



8 kg base

INFORMATION

*mm

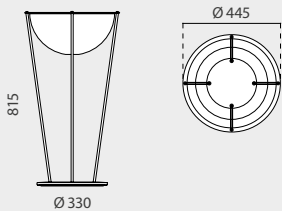

This merchandising bowl with wooden base is ideal for displaying the last minute add-on items thanks its 440mm diameter hemisphere made of transparent polycarbonate. Perfect for exhibition at playstores, malls or shops.

A.P.BOWL	QTY	N.W	G.W	C.B.M	SIZE
Semisphere	1	1.15kg	2.35kg	0.0561	492x485x235mm
Base	1	5kg	5.3kg	0.0055	350x350x45mm
50.383	Semisphere: Ø445mm Base: Ø330mm				



PROMO BOWL

Frame kit included



Ø 440mm polycarbonate semispheres



8 kg base

INFORMATION

*mm

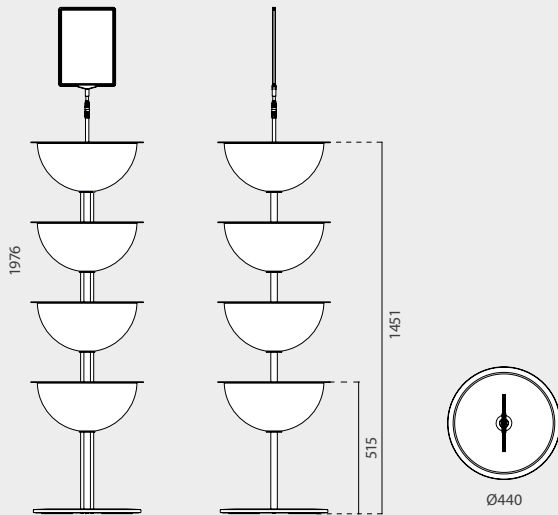

This merchandising multi-bowl is ideal for displaying the last minute add-on items thanks its 440mm diameter semispheres made of transparent polycarbonate. Adding 4 Bowls semispheres for the exhibition of more varieties of product. Perfect for exhibition of candies, cosmetics, hair accessories, and much more. Bowl displays are becoming a very popular way to showcase merchandise at playstores, malls or shops.

P.BOWL	QTY	N.W	G.W	C.B.M	SIZE
Semisphere	1	2.95kg	3.95kg	0.0714	454x455x345mm
Base+Profile	1	9kg	10kg	0.0714	455x455x345mm

10.802

Semisphere: Ø440mm

PROMO CASH



very light
to transport



INFORMATION

*mm

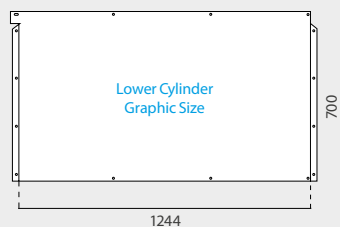
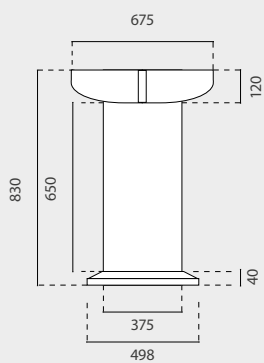

This merchandising bowl features a 675mm diameter semisphere made of plastic. It allows personalization with graphic. The Promo Bowls are ideal for the exhibition of toys, candies, cosmetics or last minute add-on items. Bowl displays are becoming a very popular way to showcase merchandise, samples or gifts at playstores, malls, shops, etc.

675mm
diameter



PROMO BRAND

easy access to the product



fully removable



INFORMATION

*mm

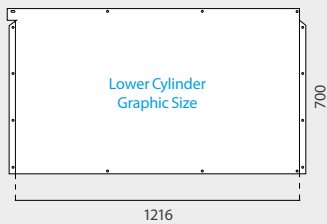
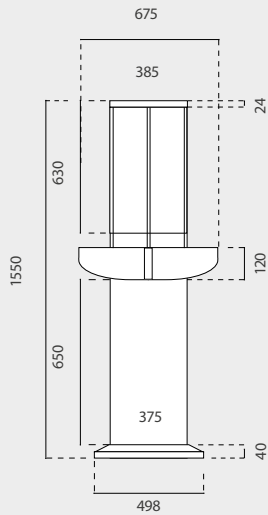

This fully removable merchandising bowl features a 675mm diameter hemisphere made of plastic and transparent cylinder for the exhibition of items. Base allows the customization with graphic. The Promo Bowls are ideal for the exhibition of toys, candies, cosmetics, merchandising, samples, gifts or last minute add-on items at playstores, malls, shops, etc.



PROMO STORE



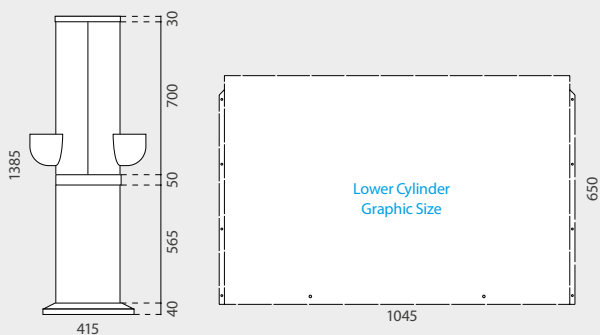

INFORMATION

*mm



This fully removable merchandising display features 2 dispensers made of plastic and a transparent divided cylinder for the exhibition of 2 classes of products. Also it is available in blue or red color and the base allows the customization with graphic. This Dispenser Display is lightweight and easy to set-up. The Promo Store is ideal for the exhibition of toys, candies, cosmetics, merchandising, samples, gifts or last minute add-on items at playstores, malls, shops, etc...

P.STORE	QTY	N.W	G.W	C.B.M	SIZE
Packing	1	2.58kg	3.93kg	0.1762	450x440x880mm

10.110	 	Graphic Size: 1045x650mm
--------	---	--------------------------



SHELF DISPLAY



4 colors of shelves available

fully removable!

INFORMATION

*mm

This fully removable, lightweight shelving plastic display features 4 colors available. With exposed sides, this 4-sided plastic shelving unit lets customers easily access the items on the display while also providing you a means to quickly restock. Easy to set up, this shelving display will look great in markets or shops.

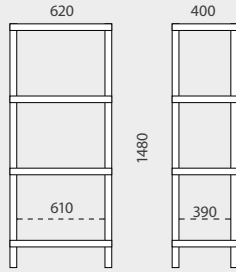

SHELF D.	QTY	N.W	G.W	C.B.M	SIZE
Packing	1	8kg	8.45kg	0.073	400x290x630mm
10.384	<input type="checkbox"/>				620x400x1480mm
10.386	<input type="checkbox"/>				
10.387	<input type="checkbox"/>				
10.388	<input type="checkbox"/>				

WIRE DUMPBIN

made of steel



INFORMATION

*mm

Wire dumpbin features a collapsible design which allows an easy setup, packing and for storing. Frame spacing allows for lifts to be used during store resets. Small model.

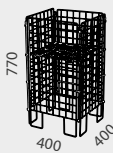

INFORMATION

*mm

Wire dumpbin features a collapsible design which allows an easy setup, packing and for storing. Frame spacing allows for lifts to be used during store resets. Medium model.

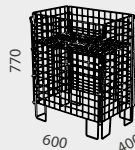

INFORMATION

*mm

Wire dumpbin features a collapsible design which allows an easy setup, packing and for storing. Frame spacing allows for lifts to be used during store resets. Big model.

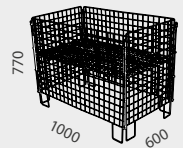

WIRE D.1	QTY	N.W	G.W	C.B.M	SIZE
Packing	1	7.2kg	8.4kg	0.2	795x425x550mm
50.350					400x400x770mm

WIRE D.2	QTY	N.W	G.W	C.B.M	SIZE
Packing	1	8.8kg	10.2kg	0.27	795x620x550mm
50.351					600x400x770mm

WIRE D.3	QTY	N.W	G.W	C.B.M	SIZE
Packing	1	13.6kg	15.2kg	0.52	1205x790x550mm
50.352					1000x600x770mm

TINEO
MULTIFUNCTION SHELF

do your own configuration:



Patent System

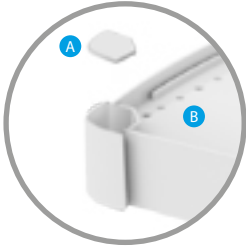

1 Get your pack of 4 top covers **A** and 4 shelves **B** (white, red or blue color)

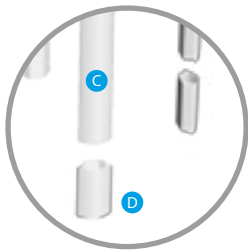

2 Combine with the pack of 12 poles **C** and 4 bottom feet **D** (white, red, blue or black)



INFORMATION

*mm

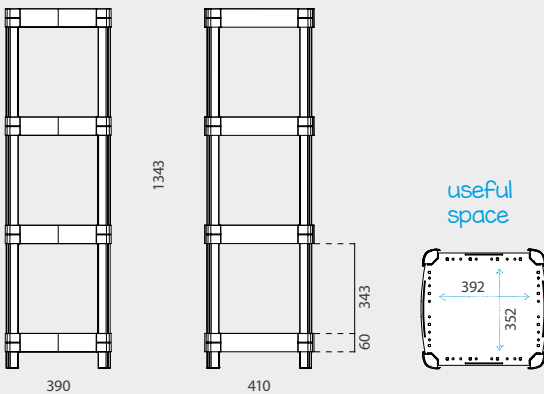

With exposed sides, this 4-sided plastic shelving unit lets customers easily access the items on display while also providing you a means to quickly restock. To make things even easier, the multi-function Tineo shelving is designed to support new configurations applied by the customer, such as turning it into a display cabinet by using panels or incorporating graphics to the sides. Easy to assemble, each piece is designed for quick installation and use. Features 3 colors for your own customization: white, red or blue. Combine your pack of 4 shelves and 4 covers with the pack of 12 poles + 4 bottom feet. If you want to turn this shelf display to mobile, wheels for Tineo are also available. Tineo has multiple functions for selling, displaying or promoting products, so is a practical display case that will look great in markets, shops, exhibition events, stores or even at home.

PACK 4 SHELVES + 4 TOP COVERS

TINEO 4S+4C	QTY	N.W	G.W	C.B.M	SIZE
Packing	1	4.1kg	4.6kg	0.0437	420x400x260mm
Shelf / Cover	<input type="checkbox"/>	<input checked="" type="checkbox"/>	<input checked="" type="checkbox"/>	<input type="checkbox"/>	
13.719	Pack: 4 shelves + 4 top covers				



PACK 12 POLES + 4 BOTTOM FEET

TINEO 12P+4F	QTY	N.W	G.W	C.B.M	SIZE
Packing	1	1.70kg	2.05kg	0.0110	415x355x75mm
Pole / Feet	<input type="checkbox"/>	<input checked="" type="checkbox"/>	<input checked="" type="checkbox"/>	<input checked="" type="checkbox"/>	<input type="checkbox"/>
13.720	Pack: 12 poles + 4 bottom feet				



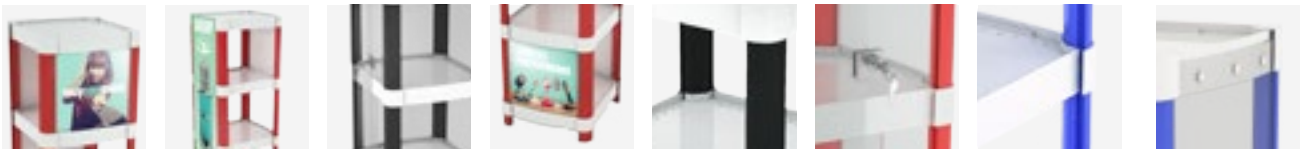

CUSTOMIZATION POSSIBILITIES (APPLIED BY THE CUSTOMER)

- EN Possibilities (applied by the customer) of turning into a cabinet display by panels or adding one or more graphics on any side.
- FR Peut (par le client) se transformer en vitrine avec l'utilisation des panneaux ou d'ajouter une ou plus visuels sur les côtes.
- PT É possível por parte do cliente converter em vitrina o artigo usando painéis ou incorporando uma ou mais impressões nos laterais.
- ES Posibilidad por parte del cliente de convertir en vitrina mediante el uso de paneles o de incorporar una o más gráficas en los laterales.



Fully removable!

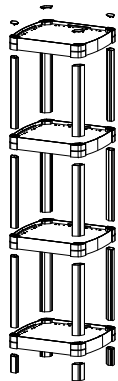

easy and fast set up!

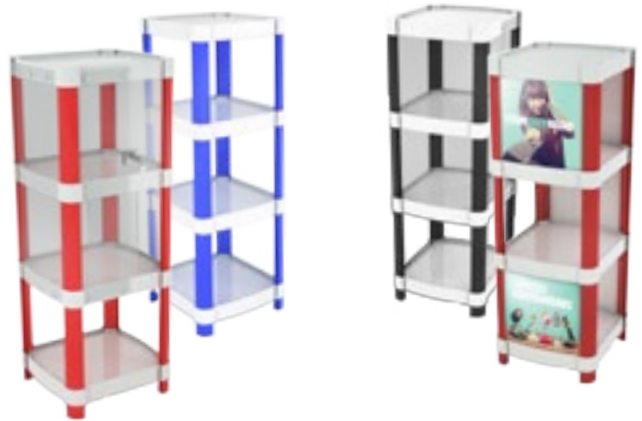
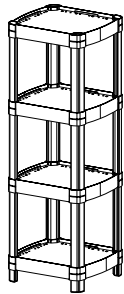

* Customization possibilities are orientative ideas, in no case are supplied with the display / * Les possible personnalisation sont à titre indicative mais ne sont pas incluses dans le display.
 * As possibilidades de personalização são orientativas, em nenhum caso são fornecidas com o artigo./ * Las posibilidades de personalización son orientativas, en ningún caso se suministran con el display.

WHEELS FOR TINEO



easily turn your shelf display from static to mobile

also with leveling feet option available



WHEELS-T.	QTY	N.W	G.W	C.B.M	SIZE
Packing	4	0.3kg	0.35kg	0.0008	130x105x60mm
14.102	2 Wheels + 2Brake Wheels	x4			

TURNTABLES | Turntables

EN Rotary and pendulum 360° motors for product exhibition. Different loads and features (LED, solar, batteries, etc...).

FR Moteurs pendulaires ou de girotoires (360°) avec différentes capacités ou caractéristiques (led, énergie solaire, batteries...).

PT Motores pendulares ou giratórios (360°) com diferentes capacidades e características (com led, a energia solar, pilhas...).

ES Motores giratorios 360° y pendulares para exhibición de producto. Diferentes prestaciones según modelo (LED, solar, baterías, etc...).

TURNTABLE ±20kg | Ø410mm

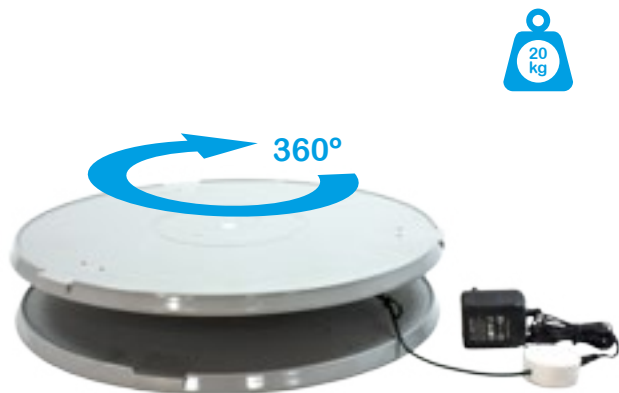

INFORMATION

- White colored.
- Ø410mm diameter plate.
- This turntable has a loading capacity of ±20kg.

TURN Ø410	QTY	N.W	G.W	C.B.M	SIZE
Packing	1	1.9kg	2.15kg	0.015	420x90x420mm
 10.987		Ø410x80mm			



TURNTABLE ±20kg | Ø200mm



INFORMATION

- Works directly plugged in.
- Plastic flange. Ø200mm diameter.
- This turntable has a load capacity of ±20kg.

TURN Ø200	QTY	N.W	G.W	C.B.M	SIZE
Packing	1	0.75kg	0.9kg	0.0048	225x75x285mm
 10.986		Ø200x60mm			

TURNTABLE ±3kg | Ø130mm



INFORMATION

- Works directly plugged in.
- White Color. Ø130mm diameter.
- This turntable has a load capacity of ±3kg.

TURN Ø130	QTY	N.W	G.W	C.B.M	SIZE
Packing	1	0.4kg	0.5kg	0.0025	150x70x240mm
 10.518		Ø130x57mm			

SOLAR PENDULUM DISPLAY ±5g



INFORMATION

- Works with solar power.
- This turntable has a loading capacity of ±5g.

S.PENDULUM	QTY	N.W	G.W	C.B.M	SIZE
Packing	1	0.04kg	0.05kg	0.0002	55x30x105mm
 10.358		100x50x30mm			

BATTERY PENDULUM DISPLAY ±14g



INFORMATION

- Works with 2 AA batteries (not included).
- This turntable has a loading capacity of ±14g.

B.PENDULUM	QTY	N.W	G.W	C.B.M	SIZE
Packing	1	0.11kg	0.14kg	0.0006	75x50x165mm
 10.063		160x70x43mm			

BATTERY TURNTABLE ±200g | Ø85mm



INFORMATION

- Works with 1 AA battery (not included).
- Ø85mm diameter. This turntable has a loading capacity of ±200g.

B.TURNTABLE	QTY	N.W	G.W	C.B.M	SIZE
Packing	1	0.12kg	0.15kg	0.0001	95x89x125mm
 10.406		Ø85x45mm			

SOLAR TURNTABLE ±200g



INFORMATION

- Works with solar power.
- This turntable has a loading capacity of ±200g.

S.TURNTABLE	QTY	N.W	G.W	C.B.M	SIZE
Packing	1	0.08kg	0.1kg	0.0004	85x45x115mm
 10.064		112x80x43mm			



INFORMATION

- 4 LEDs included. Ø85mm diameter.
- This turntable has a loading capacity of ±2kg.
- Works with batteries or directly plugged in.

B.TURN 2KG Ø85	QTY	N.W	G.W	C.B.M	SIZE
Packing	1	0.3kg	0.35kg	0.002	125x75x190mm
 10.407		Ø85x45mm		 	

BATTERY TURNTABLE ±2.5kg | Ø85/Ø120mm

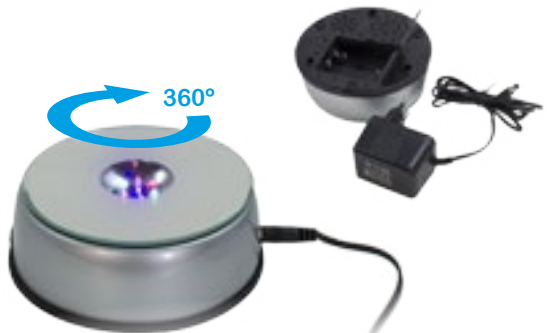

INFORMATION

- 4 LEDs included. Ø120mm diameter. loading capacity of ±2.5kg.
- Works with batteries or plugged in (turntable function only works plugged in).

B.TURN 2KG Ø120	QTY	N.W	G.W	C.B.M	SIZE
Packing	1	0.4kg	0.45kg	0.0013	127x55x197mm
 10.456		Ø120x45mm		 	



iviceversa
Soluciones
Gráficas

Soluciones
Gráficas

Avd. de Elda, 72 · 03610 · Petrer (Alicante)
info@iviceversa.com · 670 37 70 13 · www.iviceversa.com

